

Spring Plungers • headed, with ball and internal hexagon

22030.0943

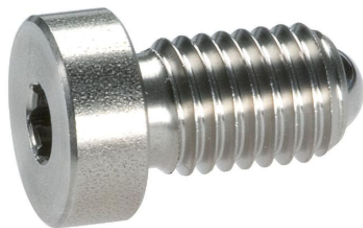

Product Description

Spring plungers can be used for locating or for applying pressure, as a detent or for ejection. Precise screwing depth due to head.

Material

Body

- Stainless steel 1.4305

Ball

- Stainless steel, hardened

Spring

- Stainless steel

Assembly

Respect dimension l_3 for M 4 / M 5.

Characteristic

Standard spring load: no marking

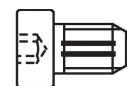
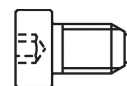

Standard spring load

Heavy spring load

More information

Notes

Special types on request.
Spring plungers are specially tested for spring range and forces.

References

Thread lock on request, please refer to appendix - Technical Data -
Calculation of indexing resistance, please refer to appendix - Technical Data -

Further products

- Locators, with bore hole, for spring plungers
- Locators, smooth, for spring plungers

Drawing

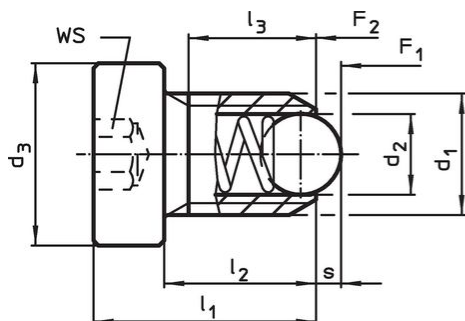

Size M4+M5

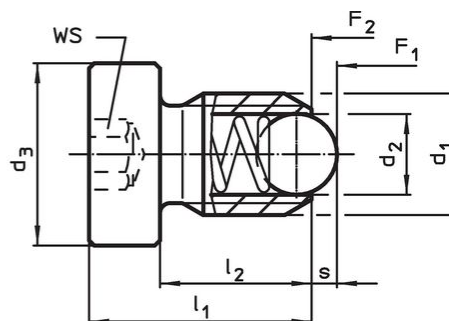

Size M6-M12

Order information

Dimensions					WS	Stroke s	Spring load ¹⁾		max. [°C]	[g]	Art. No.
d ₁	d ₂	d ₃	l ₁	l ₂			F ₁ ~ [N]	F ₂ ~ [N]			
stainless steel, standard spring load											
M8	4.5	13	18	12.5	4	1.5	18	31	250	7.8	22030.0943

¹⁾ statistical average value

Application example



Compliance

RoHS compliant

Compliant according to Directive 2011/65/EU and Directive 2015/863.

Does not contain SVHC substances

No SVHC substances with more than 0.1% w/w contained - SVHC list [REACH] as of 27.06.2024.

Does not contain Proposition 65 substances

No Proposition 65 substances included.

<https://www.P65Warnings.ca.gov/>

Free from Conflict Minerals

This product does not contain any substances designated as "conflict minerals" such as tantalum, tin, gold or tungsten from the Democratic Republic of Congo or adjacent countries.