

Spring Plungers • long version

22070.0436



Product Description

To be used for ejecting, as a detent, for applying pressure or as a shock element.

Material

- Pin**
- Steel, case-hardened, black
- Body**
- Free cutting steel, blackened
- Spring**
- Stainless steel

Assembly

Spring plungers can be mounted and removed by means of the slot or internal hexagon. Please use a special assembly tool for mounting with a slot (pin side).

Characteristic

Standard spring load: no marking



More information

Notes

Special types on request.
Spring plungers are specially tested for spring range and forces.

References

Thread lock: polyamide all-around coating (for details please refer to the technical appendix).

Drawing

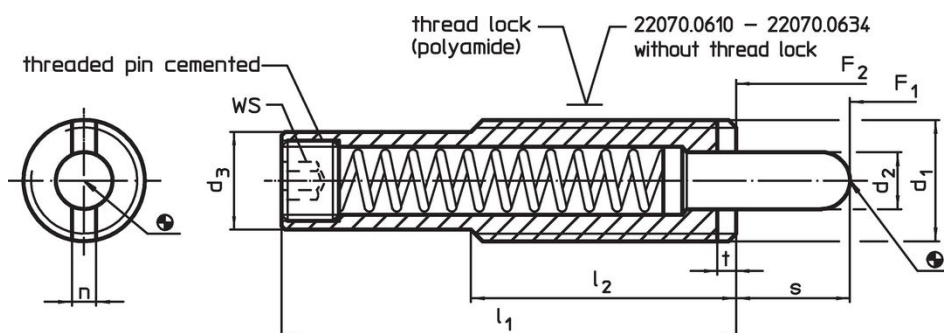

Order information

Dimensions							Stroke s [mm]	WS [mm]	Spring load ¹⁾		Temperature		Weight [g]	Art. No.
d ₁	l ₁	d ₂	d ₃	l ₂	n	t			F ₁ [N]	F ₂ [N]	min. [°C]	max. [°C]		
body from free cutting steel, standard spring load, with thread lock														
M16	58	8	13.4	35	3.2	3	15	6	9	33	-30	90	54	22070.0436

¹⁾ statistical average value

Accessories

	Dimensions				[g]	Art. No.
	d_1	b	d	l		
Assembly Tool for mounting via slot (pin sided)						
	M16	80	13.4	95	110	22070.0834

Application example



Compliance

RoHS compliant

Contains lead - compliant according to exceptions 6a / 6b / 6c.

Contains SVHC substances >0,1% w/w

Contains lead - SVHC list [REACH] as of 27.06.2024.

Contains Proposition 65 substances



Lead can cause cancer and reproductive harm from exposure
<https://www.P65Warnings.ca.gov/>

Free from Conflict Minerals

This product does not contain any substances designated as "conflict minerals" such as tantalum, tin, gold or tungsten from the Democratic Republic of Congo or adjacent countries.