

Spring Plungers · smooth, long, with collar and ball

22080.1110



Product Description

Spring plungers can be used for locating or for applying pressure, as a detent or for ejection. This version has higher spring forces than the standard version. "EH 22080. Spring Plungers, smooth, with collar and ball".

Material

Body

- Stainless steel 1.4303

Ball

- Stainless steel, hardened

Spring

- Stainless steel

More information

Notes

Special types on request.
Spring plungers are specially tested for spring range and forces.

References

Calculation of indexing resistance, please refer to appendix - Technical Data -

Further products

- Spring Plungers, smooth, with collar and ball
- Locators, with bore hole, for spring plungers
- Locators, smooth, for spring plungers

Drawing

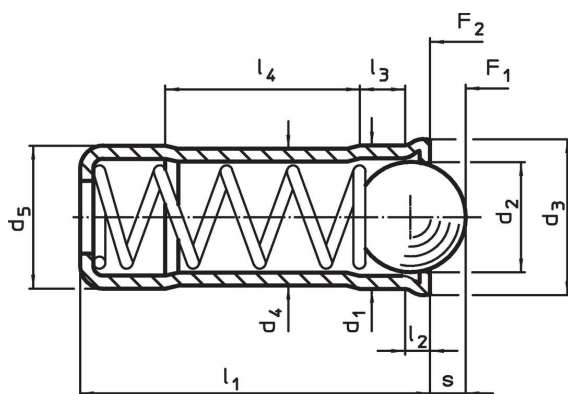

Order information

Dimensions										Stroke s +0.2 -0.1 [mm]	Spring load ¹⁾		Temperature max. [°C]	Location hole H7 [mm]	Weight [g]	Art. No.
d_1 +0.1 +0.04	d_2	d_3	d_4	d_5 ±0.04	l_1	l_2 ~	l_3 ~	l_4 ~	F_1 ~		F_2 ~	[N]				
10	8.5	11	9.55	10	26	1.5	4.2	14.3	3.1	66	105	250	10	7.6	22080.1110	

¹⁾ statistical average value

Application example



Compliance

RoHS compliant

Compliant according to Directive 2011/65/EU and Directive 2015/863.

Does not contain SVHC substances

No SVHC substances with more than 0.1% w/w contained - SVHC list [REACH] as of 27.06.2024.

Does not contain Proposition 65 substances

No Proposition 65 substances included.

<https://www.P65Warnings.ca.gov/>

Free from Conflict Minerals

This product does not contain any substances designated as "conflict minerals" such as tantalum, tin, gold or tungsten from the Democratic Republic of Congo or adjacent countries.