

Index Plungers • for thin-walled pieces

22120.0287



Product Description

Index plungers with throughgoing bore for thin-walled pieces.

Material

Body

- Steel, zinc-plated by galvanization

Locking pin

- Stainless steel 1.4305, nickel-plated

Knob

- Thermoplastic PA 6, black, dull

Assembly

By means of a fastening collet, the index plungers can be mounted into pieces having a wall thickness of 1-5 mm.

Operation

When using the self-locking type, the knob is pulled-out, turned 90° and secured by a notched catch. Depending on the clamping length, the bolt may overhang.

More information

Notes

Knob not removable.

Further products

- Locating Bushings, for index bolts and index plungers

Drawing

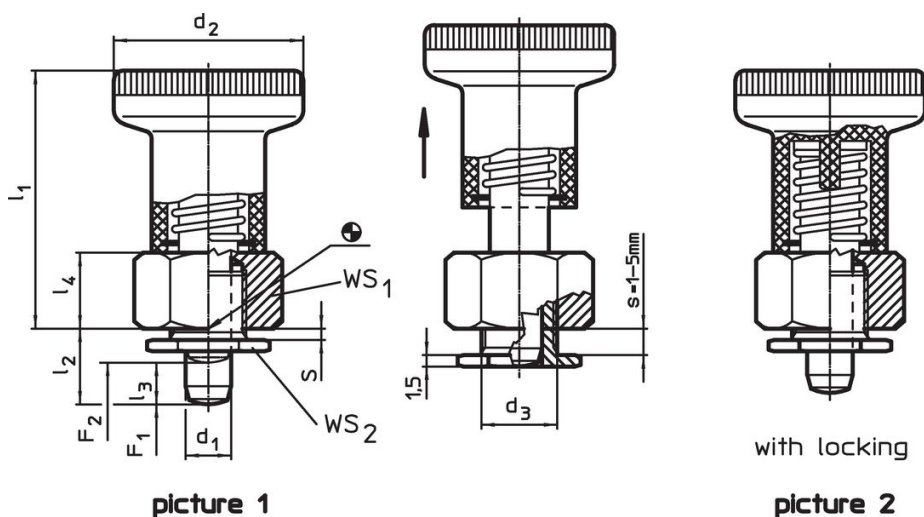



Order information

Dimensions								WS ₁	WS ₂	Spring load ¹⁾		Temperature		Weight	Art. No.
d ₁	l ₂	d ₂	d ₃	l ₁	l ₃	l ₄	s			F ₁	F ₂	min.	max.	[g]	
[mm]								[mm]	[mm]	[N]	[N]	[°C]			
-0.02 -0.05										~	~				
with locking – picture 2															
6	10.5	25	10	34	6	10	1 – 5	17	14	8.5	22	-30	80	39	22120.0287

¹⁾ statistical average value

Accessories

	 [g]	Art. No.
Ring spanner, flat		
	26	22120.0299

Application example



Compliance

RoHS compliant

Contains lead - compliant according to exceptions 6a / 6b / 6c.

Contains SVHC substances >0,1% w/w

Contains lead - SVHC list [REACH] as of 27.06.2024.

Contains Proposition 65 substances



Lead can cause cancer and reproductive harm from exposure
<https://www.P65Warnings.ca.gov/>

Free from Conflict Minerals

This product does not contain any substances designated as "conflict minerals" such as tantalum, tin, gold or tungsten from the Democratic Republic of Congo or adjacent countries.