

## Index Plungers · with hexagon collar and locking, stainless steel A4

22120.1166



### Product Description

Index plungers are used for indexing bores.  
The stainless steel A4 version ensures maximum corrosion resistance.

### Material

#### Body

- Stainless steel 1.4401

#### Locking pin

- Stainless steel 1.4401 nickel-plated

#### Knob

- Thermoplastic PA 6, black-grey, matt

#### Lock nut

- Stainless steel 1.4401

### More information

#### Notes

Knob not removable.  
Lock nuts have to be purchased separately.

### Drawing

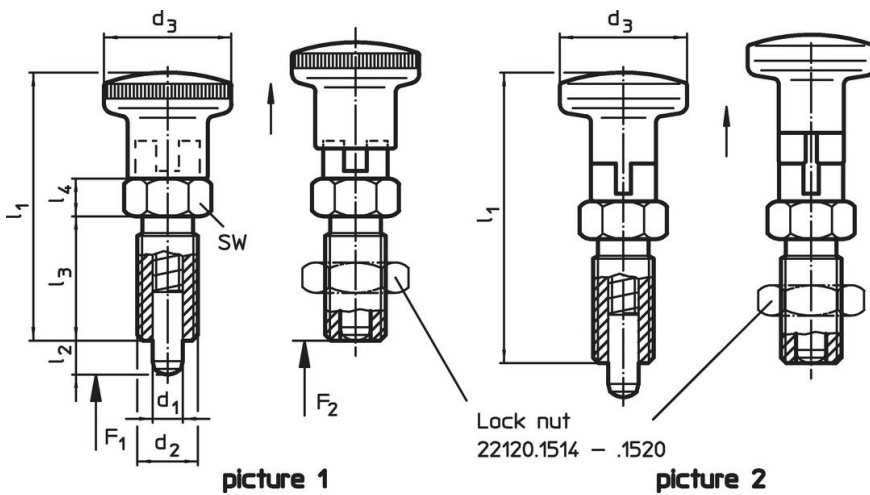



### Order information

Dimensions							Spring load <sup>1)</sup>		Temperature		Weight [g]	Art. No.
d <sub>1</sub>	d <sub>2</sub>	l <sub>2</sub> min.	d <sub>3</sub>	l <sub>1</sub>	l <sub>3</sub>	l <sub>4</sub>	F <sub>1</sub> ~	F <sub>2</sub> ~	min.	max.		
[mm]							[N]		[°C]		[g]	
-0.02 -0.05												
with knob of thermoplastic – picture 1												
6	M12 x 1,5	9	23	58	26	8	6	23	-30	80	33	22120.1166

<sup>1)</sup> statistical average value

Accessories

	Dimensions d <sub>2</sub> [mm]	Wrench size [mm]	 [g]	Art. No.
<b>Lock nuts ISO 8675 (DIN 439), Stainless steel 1.4401</b>				
	M16 x 1,5	24	18.0	22120.1518

Compliance

**RoHS compliant**

Compliant according to Directive 2011/65/EU and Directive 2015/863.

**Does not contain SVHC substances**

No SVHC substances with more than 0.1% w/w contained - SVHC list [REACH] as of 27.06.2024.

**Does not contain Proposition 65 substances**

No Proposition 65 substances included.  
<https://www.P65Warnings.ca.gov/>

**Free from Conflict Minerals**