

Index Plungers · with pull-ring

22120.1416



Product Description

Index plungers are used for indexing bores.

Material

Body

- Stainless steel 1.4305

Locking pin

- Stainless steel 1.4305, nickel-plated

Pull-ring

- Stainless steel 1.4310

Assembly

Lock nuts have to be purchased separately.

Operation

When using the model with locking mechanism, you turn the pull-ring by 90° after retracting the locking pin and secure the ring using the notched catch (if the locking pin should not overhang).

More information

Further products

- Mounting Blocks, for index bolts and index plungers, die-cast
- Locating Bushings, for index bolts and index plungers
- Distance Collars, for index plungers
- Mounting Blocks, for index bolts and index plungers

Drawing

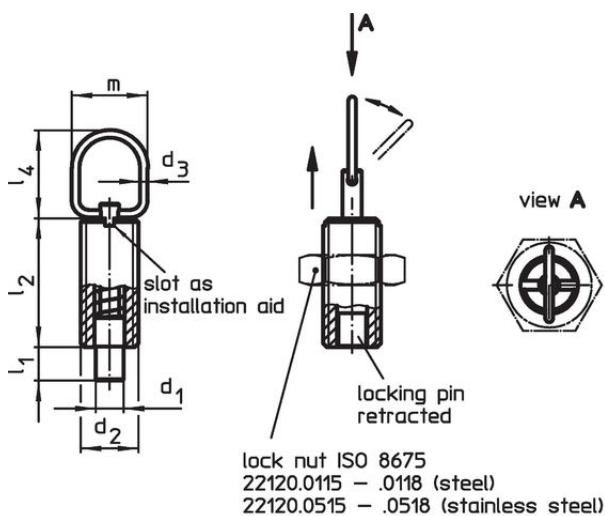

picture 1

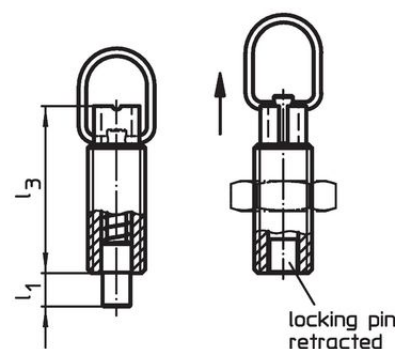

with locking

picture 2

Order information

Dimensions								Stroke s [mm]	Spring load ¹⁾		max. [°C]	[g]	Art. No.
d ₁ -0.05 -0.1	d ₂	d ₃	l ₁ min.	l ₂	l ₃	l ₄	m		F ₁ ~	F ₂ ~			
without locking – picture 1, Stainless steel													
6	M12 x 1,5	2	6	24	31	25	22	6	6	21	250	18	22120.1416

¹⁾ statistical average value

Accessories

	Dimensions d ₂ [mm]	Wrench size [mm]	[g]	Art. No.
Lock nuts ISO 8675 (DIN 439), Stainless steel				
	M12 x 1,5	18	7.5	22120.0516

Application example

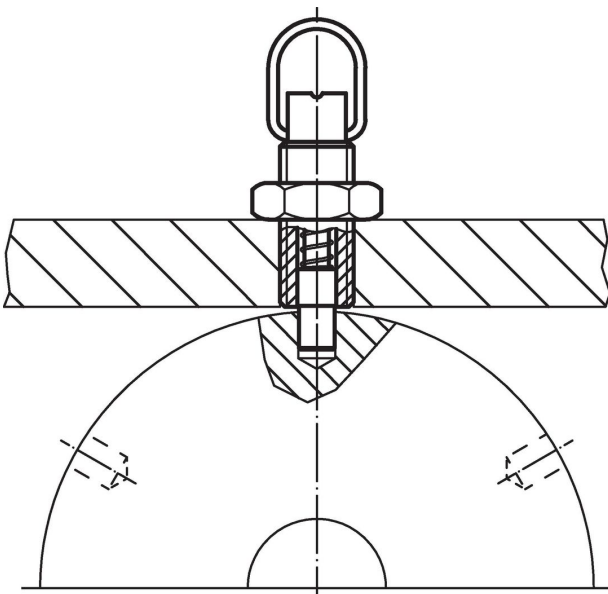

Compliance

RoHS compliant

Compliant according to Directive 2011/65/EU and Directive 2015/863.

Does not contain SVHC substances

No SVHC substances with more than 0.1% w/w contained - SVHC list [REACH] as of 27.06.2024.

Does not contain Proposition 65 substances

No Proposition 65 substances included.
<https://www.P65Warnings.ca.gov/>

Free from Conflict Minerals

This product does not contain any substances designated as "conflict minerals" such as tantalum, tin, gold or tungsten from the Democratic Republic of Congo or adjacent countries.