

Clamping Pins • self-locking, with span compensation

22360.0032



Product Description

Used for fixing and simultaneously tightly connecting thin walled plates. Clamping distance of 5 mm for clamping of sheets for welding work, for protection, coverings, to close doors etc. All versions are corrosion resistant. Version with ergonomic grip.

Material

Pin part

- Stainless steel 1.4305

Handle

- Thermoplastic PA 6, grey

Spring

- Stainless steel

Operation

The balls are unlocked by pressing the button.

More information

Accessories

Can easily be fitted with retaining cable EH 22400.

Further products

- Locating Bushings, for ball lock pins and socket pins
- Locating Bushings, with flange, for ball lock pins and socket pins
- Retaining Cables

Drawing

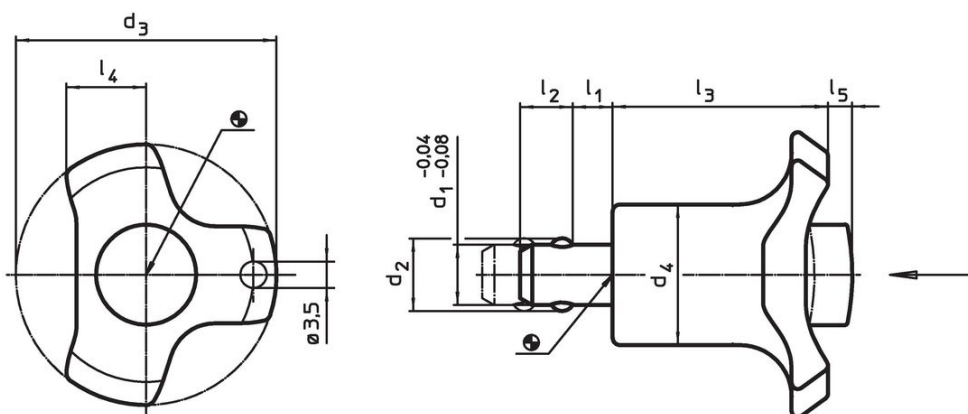

Order information

Dimensions									Location hole	Clamping force	Temperature		Weight	Art. No.
d_1	l_1	d_2	d_3	d_4	l_2	l_3	l_4	l_5	H11	max.	min.	max.	[g]	
[mm]									[mm]	[N]	[°C]			
10	5 - 10	12	47	23	8.7	36	11	4	10	23	-30	80	51	22360.0032

Application example

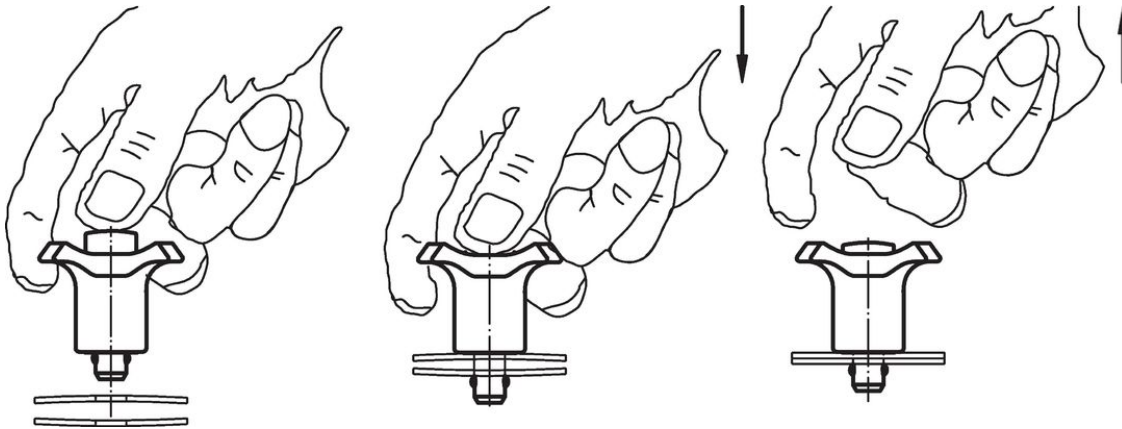

Compliance

RoHS compliant

Contains lead - compliant according to exceptions 6a / 6b / 6c.

Contains SVHC substances >0,1% w/w

Contains lead - SVHC list [REACH] as of 27.06.2024.

Contains Proposition 65 substances



Lead can cause cancer and reproductive harm from exposure
<https://www.P65Warnings.ca.gov/>

Free from Conflict Minerals

This product does not contain any substances designated as "conflict minerals" such as tantalum, tin, gold or tungsten from the Democratic Republic of Congo or adjacent countries.