

## Clamping Pins • self-locking, with span compensation

22360.0042



### Product Description

Used for fixing and simultaneously tightly connecting thin walled plates. Clamping distance of 5 mm for clamping of sheets for welding work, for protection, coverings, to close doors etc. All versions are corrosion resistant. Version with ergonomic grip.

### Material

#### Pin part

- Stainless steel 1.4305

#### Handle

- Thermoplastic PA 6, grey

#### Spring

- Stainless steel

### Operation

The balls are unlocked by pressing the button.

### More information

### Accessories

Can easily be fitted with retaining cable EH 22400.

### Further products

- Locating Bushings, for ball lock pins and socket pins
- Locating Bushings, with flange, for ball lock pins and socket pins
- Retaining Cables

### Drawing

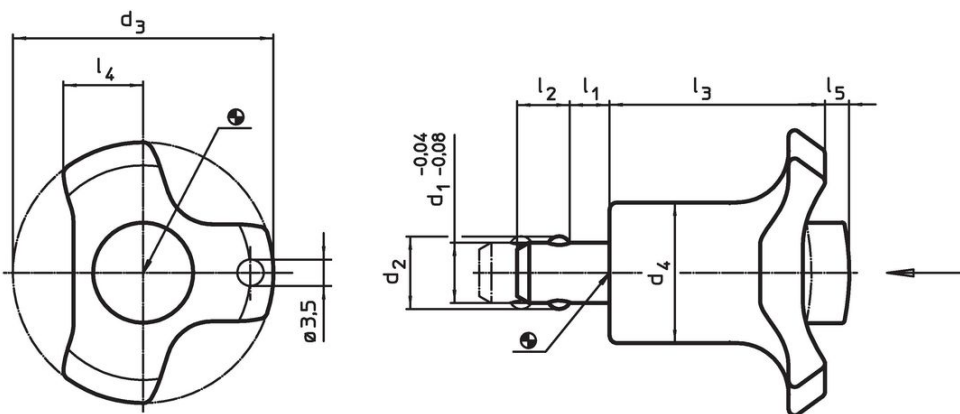

### Order information

Dimensions									Location hole H11	Clamping force max.	 min.   max.		 [g]	Art. No.	
$d_1$	$l_1$	$d_2$	$d_3$	$d_4$	$l_2$	$l_3$	$l_4$	$l_5$	[mm]	[N]	[°C]				[g]
-0.04 -0.08								Unclamped							
				[mm]					[mm]						
12	5 – 10	14	47	23	9.4	36	13.5	4	12	23	-30	80	55	22360.0042	

### Application example

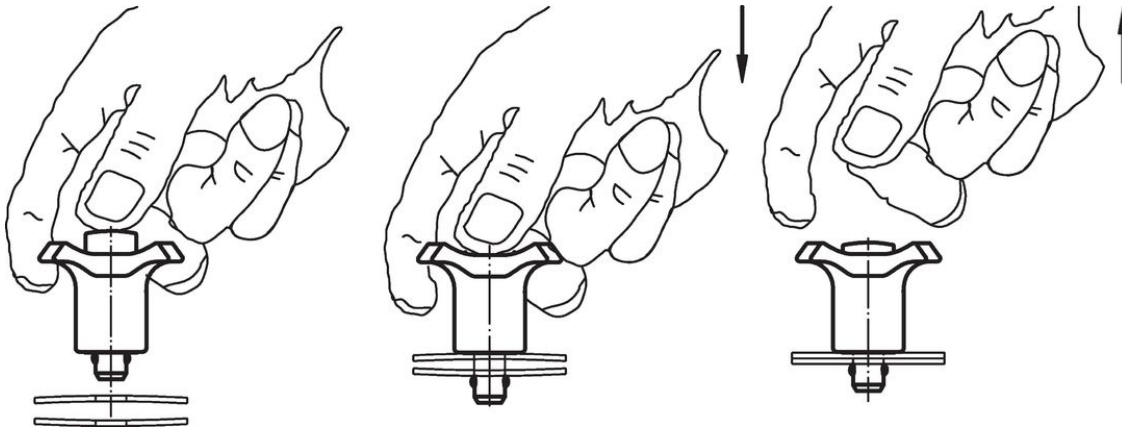

### Compliance

#### RoHS compliant

Contains lead - compliant according to exceptions 6a / 6b / 6c.

#### Contains SVHC substances >0,1% w/w

Contains lead - SVHC list [REACH] as of 27.06.2024.

#### Contains Proposition 65 substances



Lead can cause cancer and reproductive harm from exposure  
<https://www.P65Warnings.ca.gov/>

#### Free from Conflict Minerals

This product does not contain any substances designated as "conflict minerals" such as tantalum, tin, gold or tungsten from the Democratic Republic of Congo or adjacent countries.