

## Grub Screws • ball-headed 22570.0248



### Product Description

The ball-headed grub screws (EH 22570.) can be combined with plastic thrust pads (EH 22570.).

### Material

- Free cutting steel, quality 5.8, blackened

### More information

### Further products

- Thrust Pads, plastic

### Drawing



### Order information

| d <sub>1</sub> | Dimensions<br>l<br>[mm] | d <sub>2</sub><br>+0.05 | WS<br>[mm] | <br>[g] | Art. No.   |
|----------------|-------------------------|-------------------------|------------|--|------------|
| M10            | 40                      | 7.8                     | 5          | 16   | 22570.0248 |

### Application example

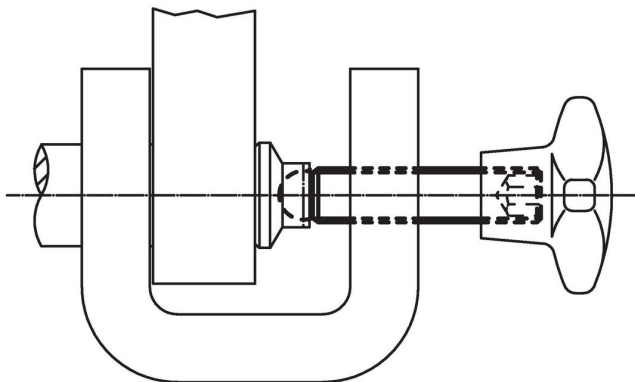

## Compliance

### RoHS compliant

Contains lead - compliant according to exceptions 6a / 6b / 6c.

### Contains SVHC substances >0,1% w/w

Contains lead - SVHC list [REACH] as of 23.01.2024.

### Contains Proposition 65 substances



Lead can cause cancer and reproductive harm from exposure  
<https://www.P65Warnings.ca.gov/>

### Free from Conflict Minerals

This product does not contain any substances designated as "conflict minerals" such as tantalum, tin, gold or tungsten from the Democratic Republic of Congo or adjacent countries.