

## Mounting Pads

22590.0456



### Product Description

Mounting pads can be used as foot or thrust pad. Not parallel bearing surfaces up to 15° degrees can be compensated.

### Material

#### Ball element with bolt

- Heat-treated steel, tempered, blackened

#### Lock nut

- Steel, blackened, DIN 934

#### Pad

- Heat-treated steel, blackened

### More information

#### Notes

For the versions  $d_1 = M10$  and  $M12$  the lock nut conforms to DIN 934.

Drawing

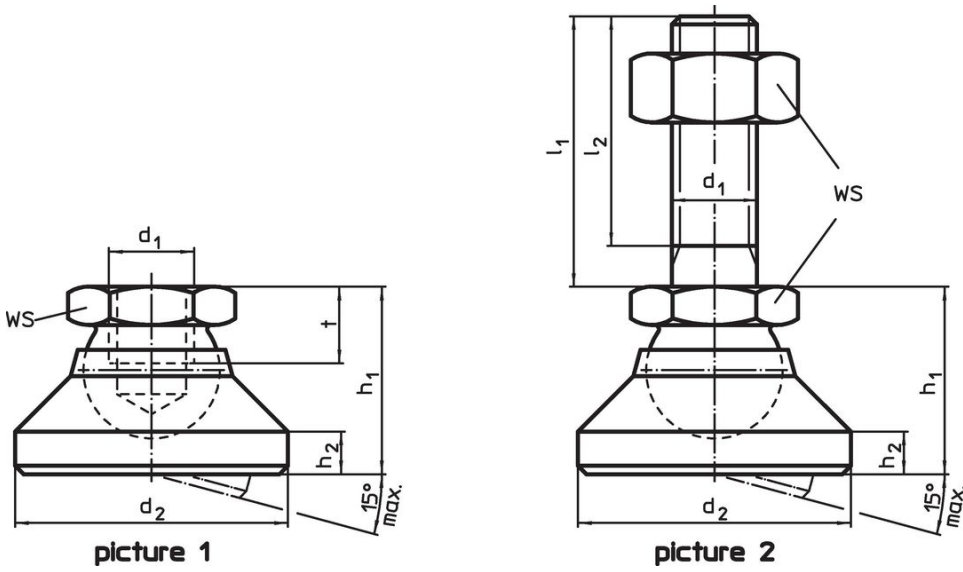

Order information

Dimensions						WS	Load capacity for static load max.	max.		Art. No.
$d_1$	$l_1$	$d_2$	$l_2$	$h_1$	$h_2$					
[mm]						[mm]	[kN]	[°C]	[g]	
pad and ball element with bolt from steel – picture 2, Heat-treated steel										
M12	150	40	144.5	26	6	19	35	250	283	22590.0456

Application example



## Compliance

### RoHS compliant

Compliant according to Directive 2011/65/EU and Directive 2015/863.

### Does not contain SVHC substances

No SVHC substances with more than 0.1% w/w contained - SVHC list [REACH] as of 27.06.2024.

### Does not contain Proposition 65 substances

No Proposition 65 substances included.

<https://www.P65Warnings.ca.gov/>

### Free from Conflict Minerals

This product does not contain any substances designated as "conflict minerals" such as tantalum, tin, gold or tungsten from the Democratic Republic of Congo or adjacent countries.