

## Ball-Ended Thrust Screws • headless, with fine-pitch thread

22720.5230



### Product Description

Ball-ended thrust screws can also be used for positioning and clamping, tightening or supporting of non-parallel surfaces.

The fine-pitch thread allows a precise adjustment.

The flat-faced, movable ball enables a flat load transmission.

### Material

#### Ball

- Ball-bearing steel, hardened

#### Screw

- Heat-treated steel,  $1200 \pm 100 \text{ N/mm}^2$

### More information

#### Notes

Ball not secured against rotating.  
Special types on request.

#### References

Thread lock on request, please refer to appendix - Technical Data -

#### Further products

- Ball-Ended Thrust Screws, headless, ball protected against rotating
- Ball-Ended Thrust Screws, headless, round ball
- Ball-Ended Thrust Screws, headless, flat-faced ball

### Drawing



picture 1



picture 2

### Order information

d <sub>1</sub>	Dimensions			WS	Load capacity for static load <sup>1)</sup> max. [kN]	max. [°C]	[g]	Art. No.
	l <sub>2</sub>	d <sub>3</sub>	Ball diameter					
flat-faced ball, bearing surface plain – picture 2, Heat-treated steel								
M4 x 0,35	5.6	1.3	2.5	2	3.5	250	0.3	22720.5230

<sup>1)</sup> Statements on load capacity are not valid for the stainless steel type.

### Application example

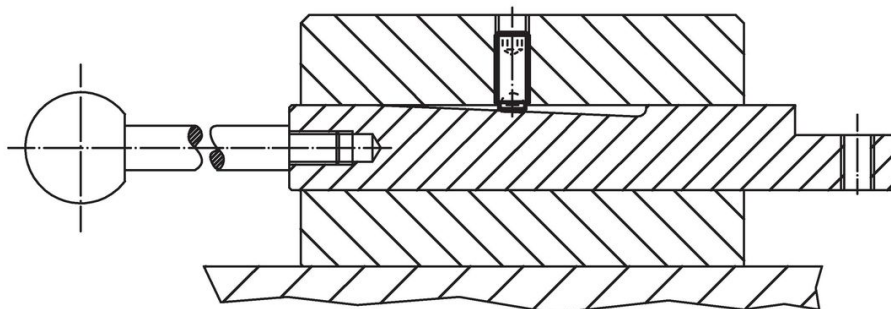

## Compliance

### RoHS compliant

Contains lead - compliant according to exceptions 6a / 6b / 6c.

### Contains SVHC substances >0,1% w/w

Contains lead - SVHC list [REACH] as of 23.01.2024.

### Contains Proposition 65 substances



Lead can cause cancer and reproductive harm from exposure  
<https://www.P65Warnings.ca.gov/>

### Free from Conflict Minerals

This product does not contain any substances designated as "conflict minerals" such as tantalum, tin, gold or tungsten from the Democratic Republic of Congo or adjacent countries.