

Centering Pins

23110.0530



Product Description

The centering pins are used for centering fixtures on pallets.

Material

- Alloyed case-hardened steel, case-hardened, ground

Drawing



Order information

Dimensions			Art. No.
d	l		
h6			
[mm]		[g]	
50	31	473	23110.0530

Application example

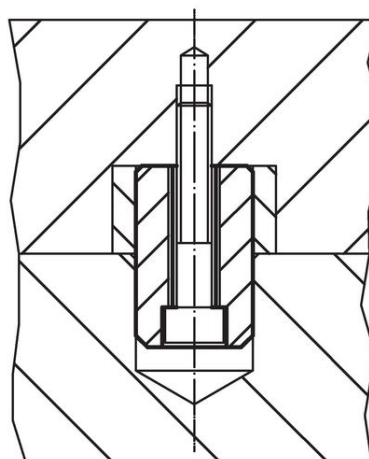

Compliance

RoHS compliant

Compliant according to Directive 2011/65/EU and Directive 2015/863.

Does not contain SVHC substances

No SVHC substances with more than 0.1% w/w contained - SVHC list [REACH] as of 27.06.2024.

Does not contain Proposition 65 substances

No Proposition 65 substances included.

<https://www.P65Warnings.ca.gov/>

Free from Conflict Minerals

This product does not contain any substances designated as "conflict minerals" such as tantalum, tin, gold or tungsten from the Democratic Republic of Congo or adjacent countries.