

Supporting Plates

23210.0870



Product Description

Various seating elements (e.g. pins EH 22690. or self-aligning pads EH 22730., EH 22731. and EH 22740.) can be mounted on the supporting plates.
The supporting plate can be moved flexibly between two threads or T-slots.
Suitable for clamping devices M 20 - M 24.

Material

- Steel, case-hardened

Drawing

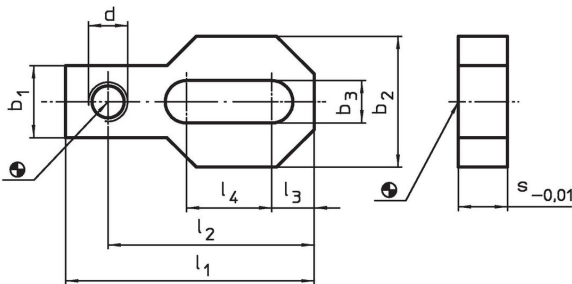

Order information

Dimensions									[kg]	Art. No.
d	l ₁	l ₂	l ₃	l ₄	b ₁	b ₂	b ₃	s -0.01		
[mm]										
M20	180	150	30	80	60	90	21	30	3	23210.0870

Application example

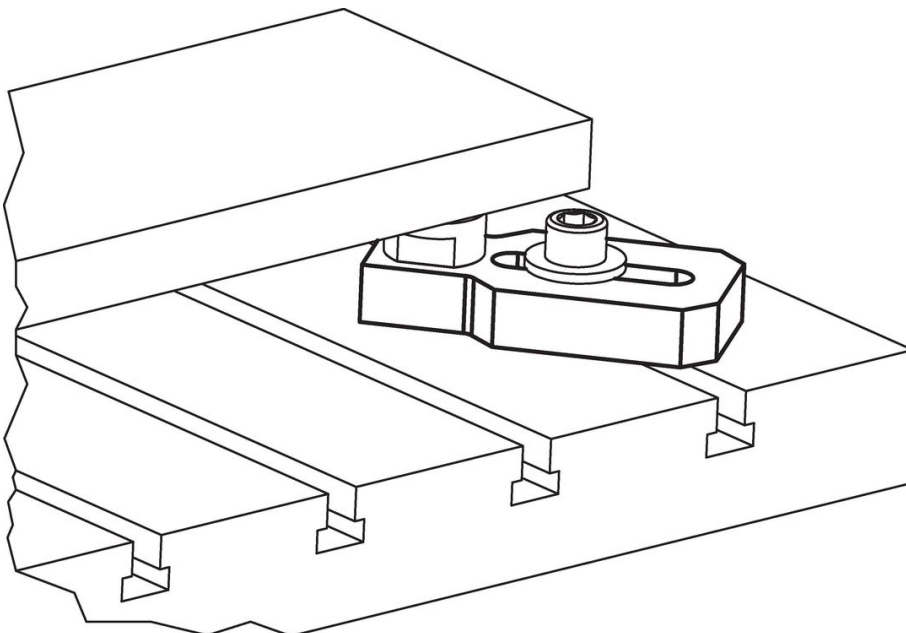

Compliance

RoHS compliant

Compliant according to Directive 2011/65/EU and Directive 2015/863.

Does not contain SVHC substances

No SVHC substances with more than 0.1% w/w contained - SVHC list [REACH] as of 27.06.2024.

Does not contain Proposition 65 substances

No Proposition 65 substances included.

<https://www.P65Warnings.ca.gov/>

Free from Conflict Minerals

This product does not contain any substances designated as "conflict minerals" such as tantalum, tin, gold or tungsten from the Democratic Republic of Congo or adjacent countries.