

## Down-Thrust Clamps · swivelling, size 25

23310.0025

**Product Description**

Universal mechanical clamping element for fast and comfortable changing and clamping of workpieces by means of manually swivelling clamping claw.

The clamps have the following advantages:

- Rapid manual clamping by means of clamping screw, adjustable clamping lever or adjustable eccentric quick clamp.
- Easy and quick changing of the workpiece by swinging away the clamping claw to the left or right. The positioning ring 23310.0345 allows infinitely variable adjustment (only with variants art no. 23310.0027 - .0029).
- The use of positioning ring 23310.0345 allows a repeatable precise clamping. Here  $h_1$  min. increases by at least 6 mm (stroke minus 6 mm).
- Compact design, thus little space taken-up for clamping.
- Easy adjustment even to large clamping heights due to the height adjusting cylinders.

As the force applied by the operator is not known for the versions with levers, the clamping force is given in the tables as a guide value. The average value was determined by tests.

**Material****Clamp**

- Case-hardened steel, case-hardened, blackened and ground

**Assembly**

Down-thrust clamps can be attached in two ways:

1. in a T-slot, using a nut for T-slots DIN 508 (EH 23010.)
  2. with the set screw directly in the mounting plate of, for example, a fixture
- The cylinder must make contact over the whole surface.

**More information****References**

The clamping height can be increased with EH 23310. height adjusting cylinders and EH 1007. washers, and equally lowered by using clamping elements e.g. EH 22730.

**Further products**

- Positioning Rings, for down-thrust clamp
- Height Adjusting Cylinders
- Spacers

Drawing

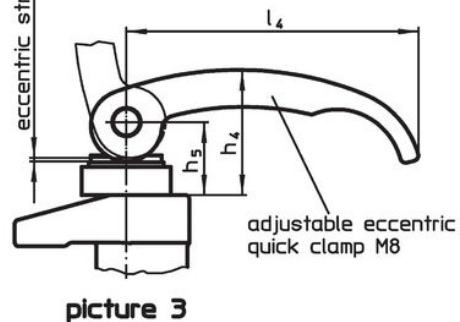
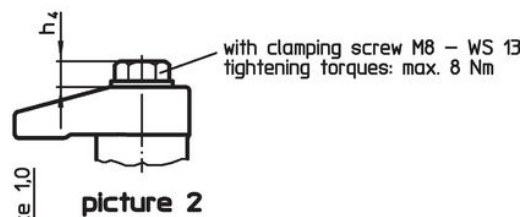
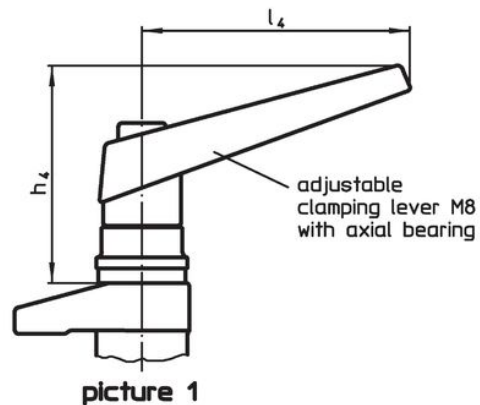
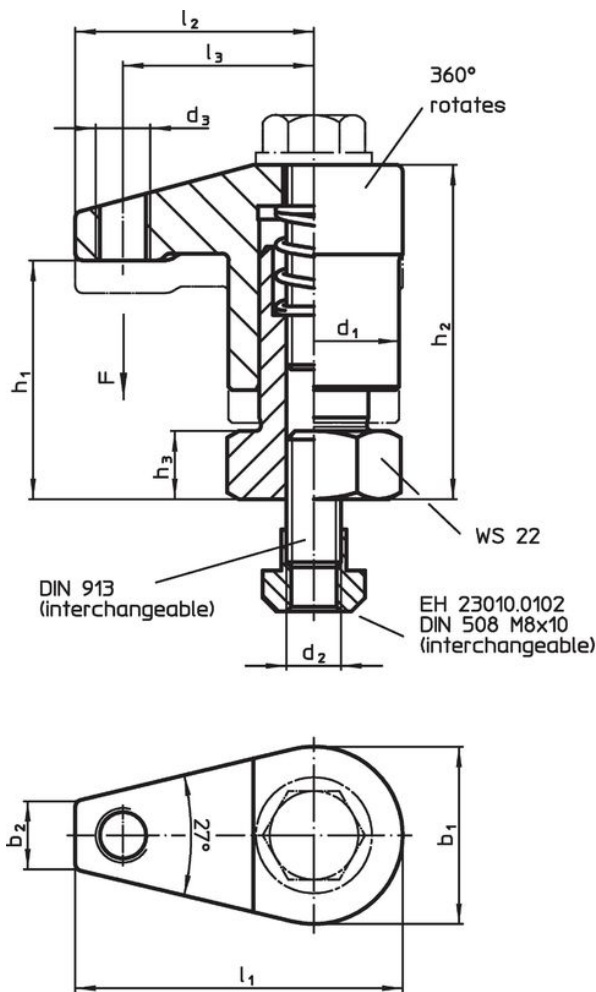

Order information

Dimensions												Stroke	Clamping force	Tightening torque max.	Weight	Art. No.
d <sub>1</sub>	b <sub>1</sub>	b <sub>2</sub>	d <sub>2</sub>	d <sub>3</sub>	h <sub>1</sub>	h <sub>2</sub>	h <sub>3</sub>	h <sub>4</sub>	l <sub>1</sub>	l <sub>2</sub>	l <sub>3</sub>					
with clamping screw – picture 2																
25	26	10	M8	M8	30 – 35	44 – 49	10	6.9	48	35	28	5	5	8	212	23310.0025

## Application example

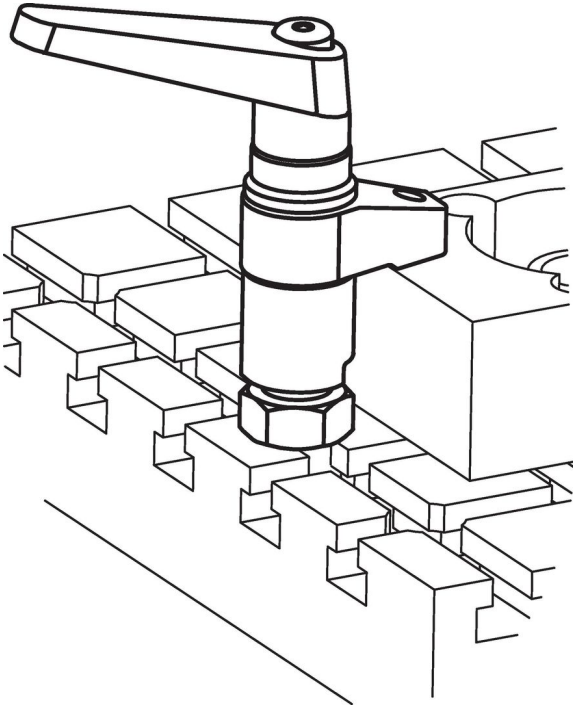

## Compliance

### RoHS compliant

Contains lead - compliant according to exceptions 6a / 6b / 6c.

### Contains SVHC substances >0,1% w/w

Contains lead - SVHC list [REACH] as of 27.06.2024.

### Contains Proposition 65 substances



Lead can cause cancer and reproductive harm from exposure  
<https://www.P65Warnings.ca.gov/>

### Free from Conflict Minerals

This product does not contain any substances designated as "conflict minerals" such as tantalum, tin, gold or tungsten from the Democratic Republic of Congo or adjacent countries.