

Clamping Jaws • for floating clamp M 12

23320.0056



Product Description

The clamping jaws can be used for floating clamps 23320.0008, 2332.0010, 23320.0012, and 23320.0014.

The upper clamping jaw (23320.0054, 23320.0056, and 23320.0058 - pictures 1 to 3) can be used to extend the clamping range.

Various standard parts can be screwed into in the upper clamping jaw as required, using locating thread M 8 (23320.0154 / .0156 - pictures 4 + 5) - see "Further products".

The lower clamping jaw with pivot function (23320.0148 - picture 6) adapts to the profiles of the workpiece.

Material

Clamping jaws

- Case-hardened steel, nitrided, manganese phosphated

More information

Notes

The tightening torque of the floating clamp must be adapted/reduced situationally. Observe the surface pressure due the the reduced contact surface of the clamping jaws.

Further products

- Seating Pins, ribbed or pointed
- Ball-Ended Thrust Screws, headless, ball protected against rotating
- Ball-Ended Thrust Screws, headless, flat-faced ball
- Thrust Screws, with brass pad
- Thrust Screws, with plastic pad
- Self-Aligning Pads, adjustable
- Self-Aligning Pads, adjustable, self-resetting

Drawing

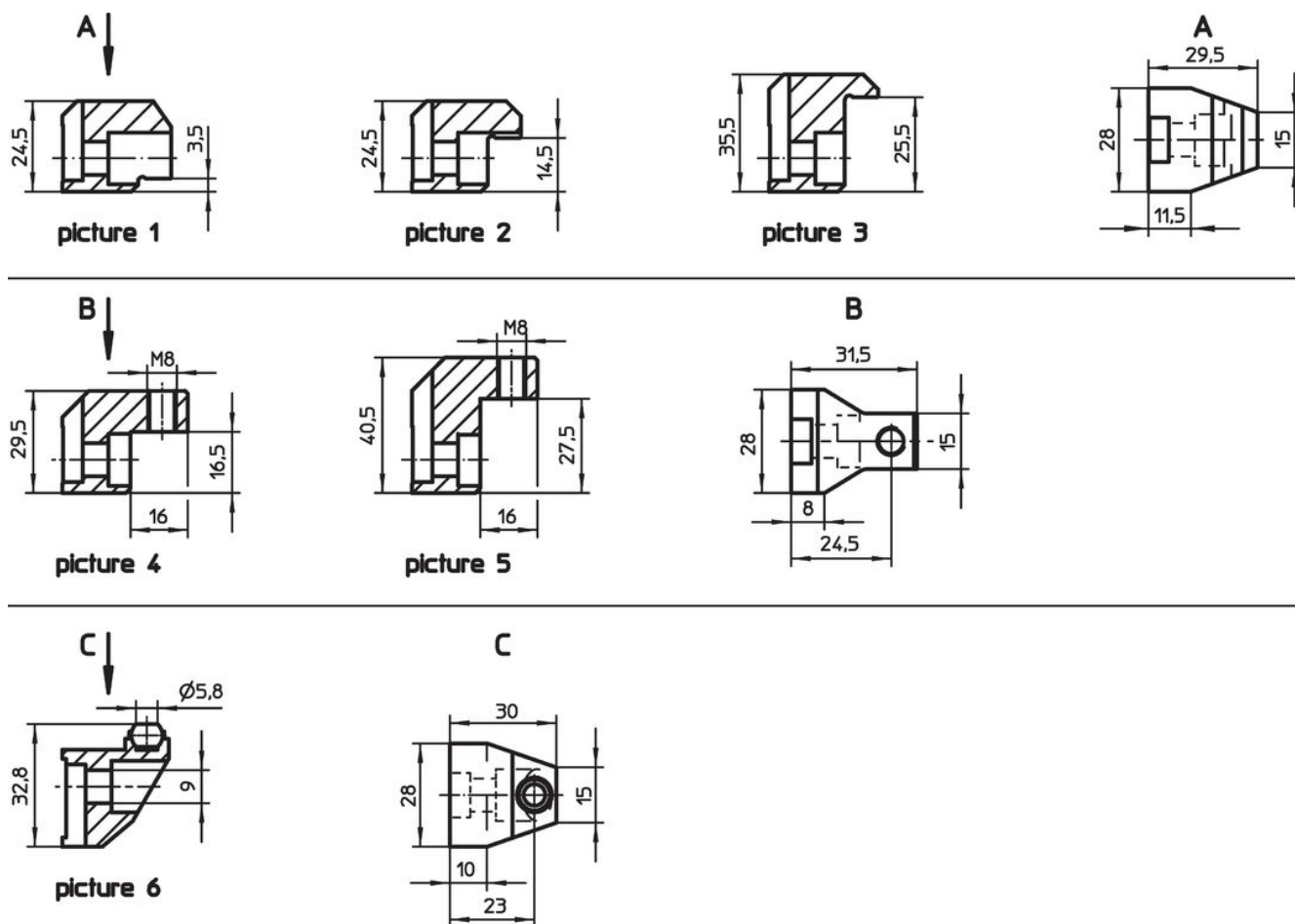

Order information

Clamping range max. in combination with 23320.0050 [mm]	[g]	Art. No.
upper exchange clamping jaw – picture 2	88	23320.0056
15 – 27	88	23320.0056

Application example

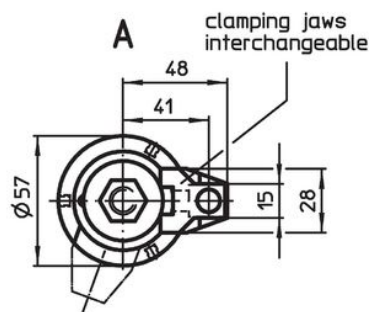
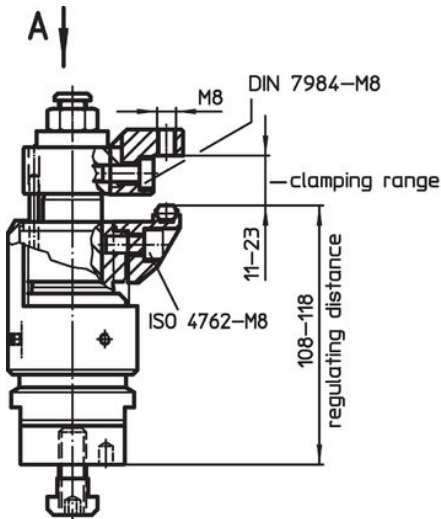

e.g. Ball-Ended Thrust Screw (EH 22720.)

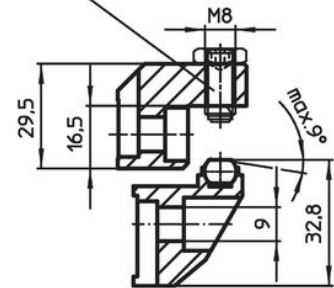

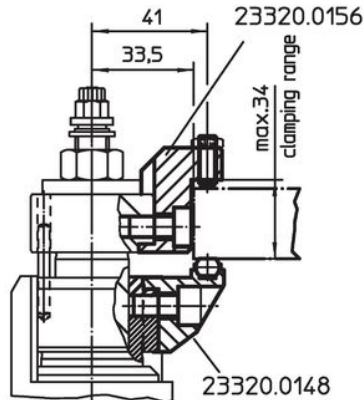
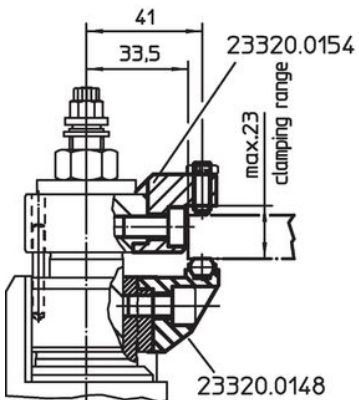
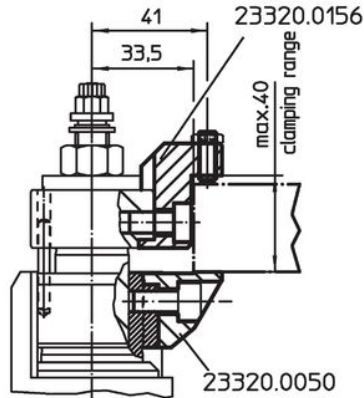
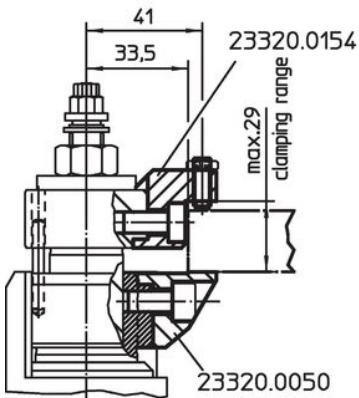
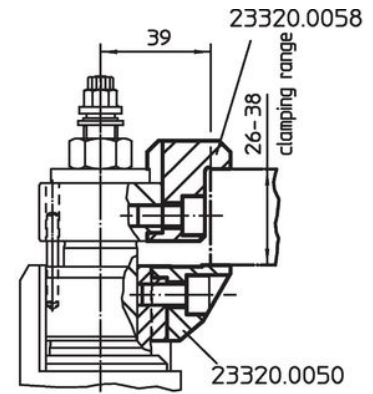
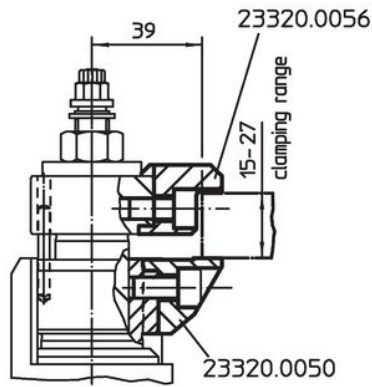
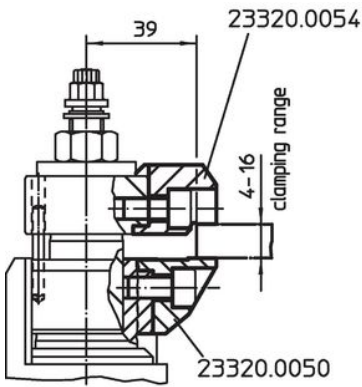

Compliance

RoHS compliant

Compliant according to Directive 2011/65/EU and Directive 2015/863.

Does not contain SVHC substances

No SVHC substances with more than 0.1% w/w contained - SVHC list [REACH] as of 27.06.2024.

Does not contain Proposition 65 substances

No Proposition 65 substances included.

<https://www.P65Warnings.ca.gov/>

Free from Conflict Minerals

This product does not contain any substances designated as "conflict minerals" such as tantalum, tin, gold or tungsten from the Democratic Republic of Congo or adjacent countries.