

## Adjustable Tension Levers

24440.0728



### Product Description

#### Material

##### Lever

- Stainless steel 1.4305, dull blasted

##### Screw

- Stainless steel 1.4305

##### Ball knob

- Thermosetting plastic PF 31, black, DIN 319

#### Operation

By lifting the lever the serrations are disengaged. The lever can be positioned by the serrations. On releasing the lever, the serrations are automatically re-engaged.

#### More information

#### Notes

The threaded portion can be exchanged.

### Drawing

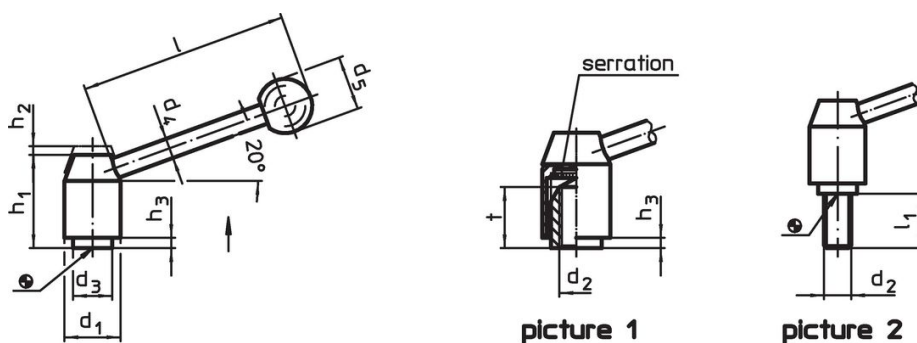

### Order information

Dimensions										[g]	Art. No.
d <sub>1</sub>	d <sub>2</sub>	l <sub>1</sub>	d <sub>3</sub>	d <sub>4</sub>	d <sub>5</sub>	h <sub>1</sub>	h <sub>2</sub>	h <sub>3</sub>	l		
[mm]											
with screw – picture 2, Stainless steel											
24	M10	40	16	10	25	40	4.5	2.5	96	184	24440.0728

### Compliance

#### RoHS compliant

Compliant according to Directive 2011/65/EU and Directive 2015/863.

#### Does not contain SVHC substances

No SVHC substances with more than 0.1% w/w contained - SVHC list [REACH] as of 27.06.2024.

#### Does not contain Proposition 65 substances

No Proposition 65 substances included.

<https://www.P65Warnings.ca.gov/>

#### Free from Conflict Minerals

This product does not contain any substances designated as "conflict minerals" such as tantalum, tin, gold or tungsten from the Democratic Republic of Congo or adjacent countries.