

Flat Knurled Thumb Screws • DIN 653

24770.0117



Product Description

Knurled thumb screws are very versatile. Three material versions for the different requirements

- steel, blackened
- steel, zinc-plated by galvanization
- stainless steel

are available.

Knurled thumb screws can be easily tightened and released by hand. The ribbed outer surface of the nut prevents slipping when tightening / releasing with the fingers.

The thread is manufactured up to the head and with runout without undercut at the end of the thread (DIN designation A). The screws can therefore not be screwed in up to the head.

Material

- Steel, blackened, quality 5.8

More information

Notes

Knurling pitch and knurling depth may differ from DIN.

Further products

- High Knurled Thumb Screws, DIN 464

Drawing

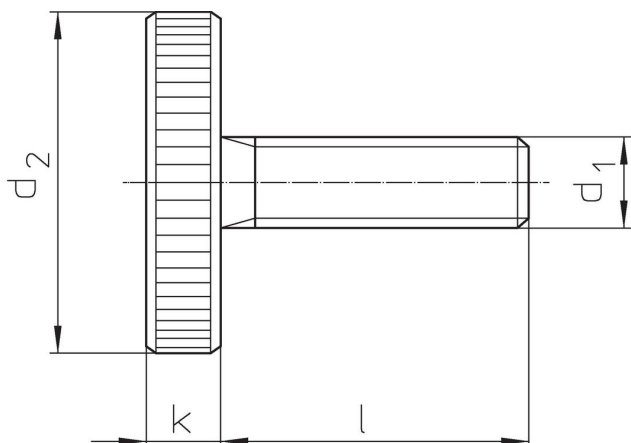

Order information

Dimensions				[g]	Art. No.
d ₁	l	d ₂	k		
[mm]					
Steel					
M5	20	20	4	12	24770.0117

Compliance

RoHS compliant

Contains lead - compliant according to exceptions 6a / 6b / 6c.

Contains SVHC substances >0,1% w/w

Contains lead - SVHC list [REACH] as of 27.06.2024.

Contains Proposition 65 substances



Lead can cause cancer and reproductive harm from exposure
<https://www.P65Warnings.ca.gov/>

Free from Conflict Minerals

This product does not contain any substances designated as "conflict minerals" such as tantalum, tin, gold or tungsten from the Democratic Republic of Congo or adjacent countries.