

## Rubber Endstop Buffers · truncated cone form

25150.1039



### Product Description

To be used as an elastic end-stop, bearing foot etc.  
The hardness is 55 ±5° shore A. Further shore hardnesses (40 ±5° shore A and 70 ±5° shore A) on request.

### Material

#### Support washer

- Stainless steel 1.4301

#### Body

- NBR

#### Screw

- Stainless steel 1.4301

### More information

#### Further products

- Support Legs, impact cushioning
- Silicone Endstop Buffers, truncated cone form

### Drawing

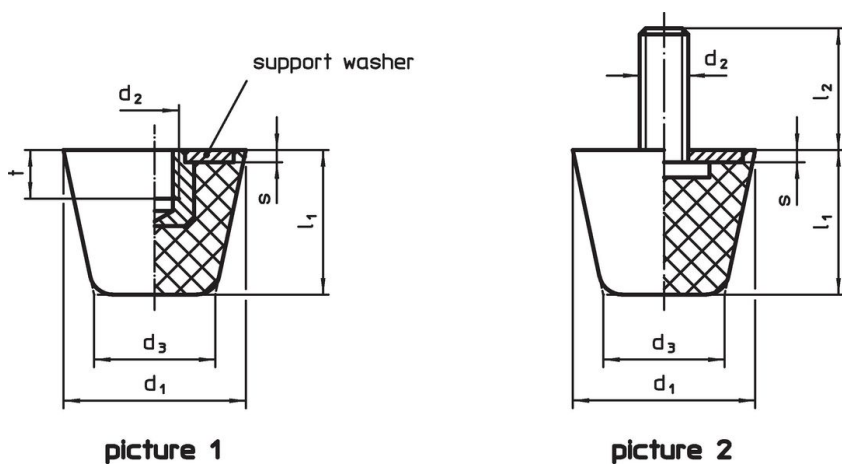

picture 1

picture 2

### Order information

Dimensions						Spring rate R	Load capacity max.	Spring range	Temperature		Weight	Art. No.
d <sub>1</sub>	d <sub>2</sub>	l <sub>2</sub>	d <sub>3</sub>	l <sub>1</sub>	s	[N/mm]	[N]	[mm]	min.	max.	[g]	
[mm]									[°C]			
with screw – picture 2, Stainless steel												
38	M8	16	24.5	32	2	125	1200	9.5	-30	80	48	25150.1039

### Compliance

#### RoHS compliant

Compliant according to Directive 2011/65/EU and Directive 2015/863.

#### Does not contain SVHC substances

No SVHC substances with more than 0.1% w/w contained - SVHC list [REACH] as of 27.06.2024.

#### Does not contain Proposition 65 substances

No Proposition 65 substances included.

<https://www.P65Warnings.ca.gov/>

#### Free from Conflict Minerals

This product does not contain any substances designated as "conflict minerals" such as tantalum, tin, gold or tungsten from the Democratic Republic of Congo or adjacent countries.