

Hinges • Zinc die-cast, with spring return

25163.0115



Product Description

Hinges from zinc die-cast with spring return allow doors to be automatically opened or closed. The torque of the reset depends on the opening angle of the hinge (refer to the drawing). Endurance tests have shown that the torque of the reset does not change even after 100,000 cycles. These hinges from zinc die-cast are characterised by their simple and timeless design.

Material

Body

- Zinc die-cast, plastic coated, black, similar to RAL 9005, matt structure

Spring

- Spring steel wire

Covering

- Thermoplastic POM

More information

Further products

- Spacer Plates, for hinges
- Threaded Plates, for hinges

Drawing

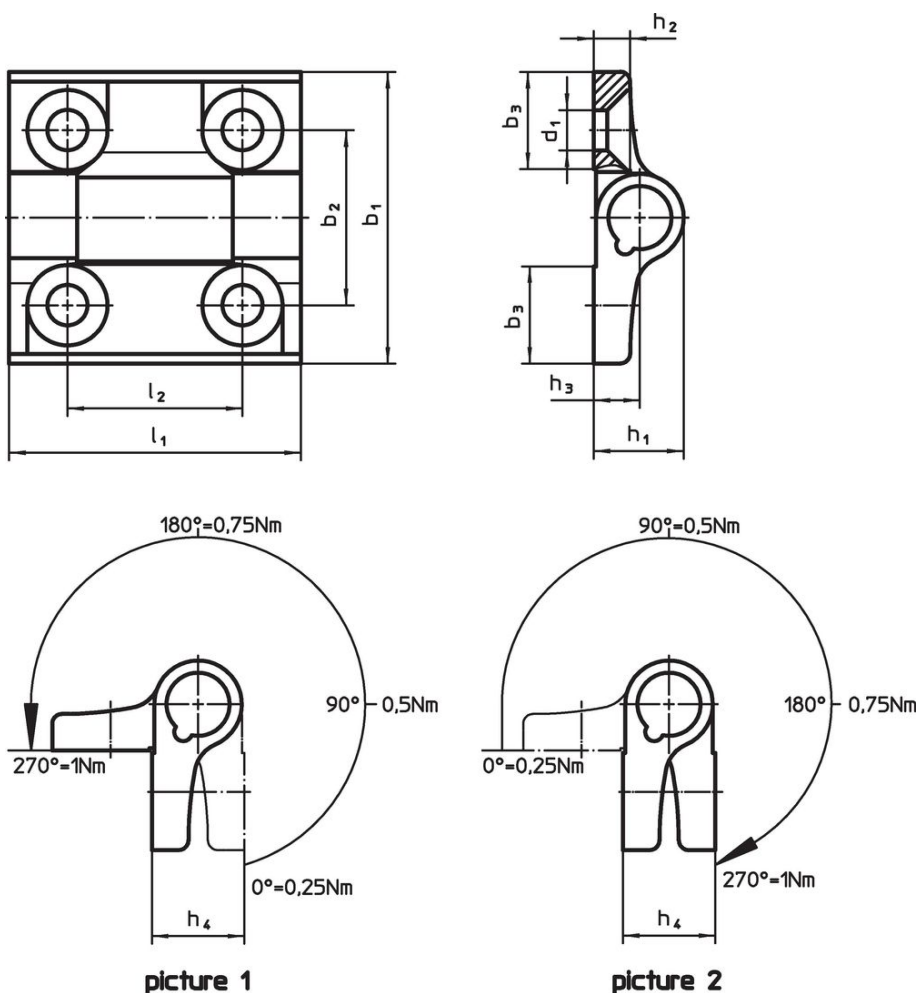

Order information

Dimensions											max. [°C]	[g]	Art. No.
b ₁	l ₁	b ₂	b ₃	d ₁	h ₁	h ₂	h ₃	h ₄	l ₂	[mm]			
spring-loaded return opening – picture 2, Zinc die-cast, black													
60	60	36	20	8.3	18.5	7.5	9.5	19	36	80	146	25163.0115	

Compliance

RoHS compliant

Compliant according to Directive 2011/65/EU and Directive 2015/863.

Does not contain SVHC substances

No SVHC substances with more than 0.1% w/w contained - SVHC list [REACH] as of 27.06.2024.

Does not contain Proposition 65 substances

No Proposition 65 substances included.

<https://www.P65Warnings.ca.gov/>

Free from Conflict Minerals

This product does not contain any substances designated as "conflict minerals" such as tantalum, tin, gold or tungsten from the Democratic Republic of Congo or adjacent countries.