

Ball Lock Pins • self-locking, with T-Handle

EH 22340. /EH 22350.



Product Description

For quick fastening, locking, adjusting, changing and securing. Quickly and easily unlockable for frequently repeated connections.

All versions are corrosion resistant. When using stainless steel 1.4542: high-strength, hardened, abrasion resistant pin with high load capacity.

Version with ergonomic grip.

Material

Pin part

- Stainless steel 1.4305
- Stainless steel 1.4542, precipitation-hardened

Handle

- Aluminium, black similar to RAL 9005

Press button

- Stainless steel, black

Spring

- Stainless steel

Operation

The balls are unlocked by pressing the button.

Characteristic

Types from stainless steel 1.4542 with marking below the balls.

More information

Notes

Customized design on request.

- This product is also available in INCH dimensions.

Accessories

Can easily be fitted with retaining cable EH 22400.

Further products

- Locating Bushings, for ball lock pins and socket pins
- Locating Bushings, with flange, for ball lock pins and socket pins
- Retaining Cables
- Positioning Bushings, with collar, DIN 172 A
- Positioning Bushings, without collar, DIN 179 A
- Ball Lock Pins with T-Handle, single acting - comply with NAS / MS17985

Drawing





** Types from stainless steel 1.4542 with marking.



Order information

d ₁ -0.04 -0.08	l ₁ +0.6	d ₂	d ₃	Dimensions					Location hole H11	Temperature		Weight	Shearing resistance, two-shear ¹⁾ min.	Art. No.
				l ₂ ±1	l ₃	l ₄	l ₅	l ₆		min.	max.			
[mm]										[°C]		[g]	[kN]	
Stainless steel 1.4305														
5	10	5.5	11.8	6.0	31.6	24.1	45.2	12.7	5	-30	150	19	14	22340.0012
5	15	5.5	11.8	6.0	31.6	24.1	45.2	12.7	5	-30	150	20	14	22340.0013
5	20	5.5	11.8	6.0	31.6	24.1	45.2	12.7	5	-30	150	21	14	22340.0014
5	25	5.5	11.8	6.0	31.6	24.1	45.2	12.7	5	-30	150	22	14	22340.0015
5	30	5.5	11.8	6.0	31.6	24.1	45.2	12.7	5	-30	150	22	14	22340.0016
5	35	5.5	11.8	6.0	31.6	24.1	45.2	12.7	5	-30	150	23	14	22340.0017
5	40	5.5	11.8	6.0	31.6	24.1	45.2	12.7	5	-30	150	24	14	22340.0018
5	45	5.5	11.8	6.0	31.6	24.1	45.2	12.7	5	-30	150	24	14	22340.0007
5	50	5.5	11.8	6.0	31.6	24.1	45.2	12.7	5	-30	150	25	14	22340.0008
5	60	5.5	11.8	6.0	31.6	24.1	45.2	12.7	5	-30	150	27	14	22340.0009
5	70	5.5	11.8	6.0	31.6	24.1	45.2	12.7	5	-30	150	28	14	22340.0010
5	80	5.5	11.8	6.0	31.6	24.1	45.2	12.7	5	-30	150	30	14	22340.0011
6	10	7.0	11.8	7.0	31.6	24.1	45.2	12.7	6	-30	150	21	21	22340.0022
6	15	7.0	11.8	7.0	31.6	24.1	45.2	12.7	6	-30	150	21	21	22340.0023
6	20	7.0	11.8	7.0	31.6	24.1	45.2	12.7	6	-30	150	23	21	22340.0024
6	25	7.0	11.8	7.0	31.6	24.1	45.2	12.7	6	-30	150	23	21	22340.0025
6	30	7.0	11.8	7.0	31.6	24.1	45.2	12.7	6	-30	150	24	21	22340.0026
6	35	7.0	11.8	7.0	31.6	24.1	45.2	12.7	6	-30	150	26	21	22340.0027
6	40	7.0	11.8	7.0	31.6	24.1	45.2	12.7	6	-30	150	26	21	22340.0028
6	45	7.0	11.8	7.0	31.6	24.1	45.2	12.7	6	-30	150	27	21	22340.0029
6	50	7.0	11.8	7.0	31.6	24.1	45.2	12.7	6	-30	150	29	21	22340.0030
6	60	7.0	11.8	7.0	31.6	24.1	45.2	12.7	6	-30	150	30	21	22340.0019
6	70	7.0	11.8	7.0	31.6	24.1	45.2	12.7	6	-30	150	33	21	22340.0020
6	80	7.0	11.8	7.0	31.6	24.1	45.2	12.7	6	-30	150	34	21	22340.0021
8	10	9.5	14.7	8.2	35.8	26.9	51.5	15.8	8	-30	150	34	38	22340.0032
8	15	9.5	14.7	8.2	35.8	26.9	51.5	15.8	8	-30	150	36	38	22340.0033
8	20	9.5	14.7	8.2	35.8	26.9	51.5	15.8	8	-30	150	38	38	22340.0034
8	25	9.5	14.7	8.2	35.8	26.9	51.5	15.8	8	-30	150	39	38	22340.0035
8	30	9.5	14.7	8.2	35.8	26.9	51.5	15.8	8	-30	150	41	38	22340.0036
8	35	9.5	14.7	8.2	35.8	26.9	51.5	15.8	8	-30	150	43	38	22340.0037
8	40	9.5	14.7	8.2	35.8	26.9	51.5	15.8	8	-30	150	45	38	22340.0038
8	45	9.5	14.7	8.2	35.8	26.9	51.5	15.8	8	-30	150	47	38	22340.0039
8	50	9.5	14.7	8.2	35.8	26.9	51.5	15.8	8	-30	150	49	38	22340.0040
8	60	9.5	14.7	8.2	35.8	26.9	51.5	15.8	8	-30	150	52	38	22340.0031
8	70	9.5	14.7	8.2	35.8	26.9	51.5	15.8	8	-30	150	56	38	22340.0041
8	80	9.5	14.7	8.2	35.8	26.9	51.5	15.8	8	-30	150	60	38	22340.0042
8	90	9.5	14.7	8.2	35.8	26.9	51.5	15.8	8	-30	150	63	38	22340.0043
8	100	9.5	14.7	8.2	35.8	26.9	51.5	15.8	8	-30	150	67	38	22340.0051
10	15	12.0	14.7	9.6	35.8	26.9	51.5	15.8	10	-30	150	41	60	22340.0059
10	20	12.0	14.7	9.6	35.8	26.9	51.5	15.8	10	-30	150	44	60	22340.0044
10	25	12.0	14.7	9.6	35.8	26.9	51.5	15.8	10	-30	150	47	60	22340.0045
10	30	12.0	14.7	9.6	35.8	26.9	51.5	15.8	10	-30	150	50	60	22340.0046
10	35	12.0	14.7	9.6	35.8	26.9	51.5	15.8	10	-30	150	53	60	22340.0047
10	40	12.0	14.7	9.6	35.8	26.9	51.5	15.8	10	-30	150	56	60	22340.0048
10	45	12.0	14.7	9.6	35.8	26.9	51.5	15.8	10	-30	150	59	60	22340.0049
10	50	12.0	14.7	9.6	35.8	26.9	51.5	15.8	10	-30	150	62	60	22340.0050
10	60	12.0	14.7	9.6	35.8	26.9	51.5	15.8	10	-30	150	68	60	22340.0052
10	70	12.0	14.7	9.6	35.8	26.9	51.5	15.8	10	-30	150	74	60	22340.0053
10	80	12.0	14.7	9.6	35.8	26.9	51.5	15.8	10	-30	150	79	60	22340.0054
10	90	12.0	14.7	9.6	35.8	26.9	51.5	15.8	10	-30	150	85	60	22340.0055
10	100	12.0	14.7	9.6	35.8	26.9	51.5	15.8	10	-30	150	91	60	22340.0056
10	110	12.0	14.7	9.6	35.8	26.9	51.5	15.8	10	-30	150	97	60	22340.0057
10	120	12.0	14.7	9.6	35.8	26.9	51.5	15.8	10	-30	150	103	60	22340.0058
12	20	14.5	18.2	10.6	35.1	25.3	59.1	20.2	12	-30	150	69	87	22340.0064
12	25	14.5	18.2	10.6	35.1	25.3	59.1	20.2	12	-30	150	72	87	22340.0065



¹⁾ Shearing resistance similar to DIN 50141

d ₁ -0.04 -0.08	l ₁ +0.6	Dimensions							Location hole H11 [mm]	 min. max.		 [g]	Shearing resistance, two-shear ¹⁾ min. [kN]	Art. No.
		d ₂	d ₃	l ₂ ±1	l ₃	l ₄	l ₅	l ₆		[°C]				
		[mm]								[°C]				
12	30	14.5	18.2	10.6	35.1	25.3	59.1	20.2	12	-30	150	77	87	22340.0066
12	35	14.5	18.2	10.6	35.1	25.3	59.1	20.2	12	-30	150	81	87	22340.0067
12	40	14.5	18.2	10.6	35.1	25.3	59.1	20.2	12	-30	150	85	87	22340.0068
12	45	14.5	18.2	10.6	35.1	25.3	59.1	20.2	12	-30	150	89	87	22340.0069
12	50	14.5	18.2	10.6	35.1	25.3	59.1	20.2	12	-30	150	94	87	22340.0070
12	60	14.5	18.2	10.6	35.1	25.3	59.1	20.2	12	-30	150	102	87	22340.0072
12	70	14.5	18.2	10.6	35.1	25.3	59.1	20.2	12	-30	150	111	87	22340.0074
12	80	14.5	18.2	10.6	35.1	25.3	59.1	20.2	12	-30	150	119	87	22340.0076
12	90	14.5	18.2	10.6	35.1	25.3	59.1	20.2	12	-30	150	127	87	22340.0060
12	100	14.5	18.2	10.6	35.1	25.3	59.1	20.2	12	-30	150	136	87	22340.0061
12	110	14.5	18.2	10.6	35.1	25.3	59.1	20.2	12	-30	150	146	87	22340.0062
12	120	14.5	18.2	10.6	35.1	25.3	59.1	20.2	12	-30	150	154	87	22340.0063
16	30	19.0	23.4	14.0	42.2	29.8	74.8	24.7	16	-30	150	153	155	22340.0071
16	35	19.0	23.4	14.0	42.2	29.8	74.8	24.7	16	-30	150	161	155	22340.0073
16	40	19.0	23.4	14.0	42.2	29.8	74.8	24.7	16	-30	150	168	155	22340.0075
16	45	19.0	23.4	14.0	42.2	29.8	74.8	24.7	16	-30	150	172	155	22340.0077
16	50	19.0	23.4	14.0	42.2	29.8	74.8	24.7	16	-30	150	184	155	22340.0078
16	60	19.0	23.4	14.0	42.2	29.8	74.8	24.7	16	-30	150	200	155	22340.0079
16	70	19.0	23.4	14.0	42.2	29.8	74.8	24.7	16	-30	150	214	155	22340.0080
16	80	19.0	23.4	14.0	42.2	29.8	74.8	24.7	16	-30	150	231	155	22340.0081
16	90	19.0	23.4	14.0	42.2	29.8	74.8	24.7	16	-30	150	245	155	22340.0082
16	100	19.0	23.4	14.0	42.2	29.8	74.8	24.7	16	-30	150	260	155	22340.0083
16	110	19.0	23.4	14.0	42.2	29.8	74.8	24.7	16	-30	150	277	155	22340.0084
16	120	19.0	23.4	14.0	42.2	29.8	74.8	24.7	16	-30	150	293	155	22340.0085
16	130	19.0	23.4	14.0	42.2	29.8	74.8	24.7	16	-30	150	309	155	22340.0086
16	140	19.0	23.4	14.0	42.2	29.8	74.8	24.7	16	-30	150	324	155	22340.0087
16	150	19.0	23.4	14.0	42.2	29.8	74.8	24.7	16	-30	150	339	155	22340.0088
20	50	24.8	23.4	17.0	43.1	29.8	74.8	24.7	20	-30	150	245	244	22340.0089
20	60	24.8	23.4	17.0	43.1	29.8	74.8	24.7	20	-30	150	269	244	22340.0090
20	70	24.8	23.4	17.0	43.1	29.8	74.8	24.7	20	-30	150	293	244	22340.0091
20	80	24.8	23.4	17.0	43.1	29.8	74.8	24.7	20	-30	150	315	244	22340.0092
20	90	24.8	23.4	17.0	43.1	29.8	74.8	24.7	20	-30	150	340	244	22340.0093
20	100	24.8	23.4	17.0	43.1	29.8	74.8	24.7	20	-30	150	364	244	22340.0094
20	110	24.8	23.4	17.0	43.1	29.8	74.8	24.7	20	-30	150	390	244	22340.0095
20	120	24.8	23.4	17.0	43.1	29.8	74.8	24.7	20	-30	150	413	244	22340.0096
20	130	24.8	23.4	17.0	43.1	29.8	74.8	24.7	20	-30	150	436	244	22340.0097
20	140	24.8	23.4	17.0	43.1	29.8	74.8	24.7	20	-30	150	462	244	22340.0098
20	150	24.8	23.4	17.0	43.1	29.8	74.8	24.7	20	-30	150	487	244	22340.0099
25	50	31.0	30.4	22.0	54.8	37.5	88.7	33.2	25	-30	150	449	386	22340.0100
25	60	31.0	30.4	22.0	54.8	37.5	88.7	33.2	25	-30	150	487	386	22340.0101
25	70	31.0	30.4	22.0	54.8	37.5	88.7	33.2	25	-30	150	526	386	22340.0102
25	80	31.0	30.4	22.0	54.8	37.5	88.7	33.2	25	-30	150	559	386	22340.0103
25	90	31.0	30.4	22.0	54.8	37.5	88.7	33.2	25	-30	150	600	386	22340.0104
25	100	31.0	30.4	22.0	54.8	37.5	88.7	33.2	25	-30	150	640	386	22340.0001
25	110	31.0	30.4	22.0	54.8	37.5	88.7	33.2	25	-30	150	669	386	22340.0002
25	120	31.0	30.4	22.0	54.8	37.5	88.7	33.2	25	-30	150	713	386	22340.0003
25	130	31.0	30.4	22.0	54.8	37.5	88.7	33.2	25	-30	150	751	386	22340.0004
25	140	31.0	30.4	22.0	54.8	37.5	88.7	33.2	25	-30	150	788	386	22340.0005
25	150	31.0	30.4	22.0	54.8	37.5	88.7	33.2	25	-30	150	825	386	22340.0006
Stainless steel 1.4542, precipitation-hardened														
5	10	5.5	11.8	6.0	31.6	24.1	45.2	12.7	5	-30	150	19	24	22350.0012
5	15	5.5	11.8	6.0	31.6	24.1	45.2	12.7	5	-30	150	20	24	22350.0013
5	20	5.5	11.8	6.0	31.6	24.1	45.2	12.7	5	-30	150	21	24	22350.0014
5	25	5.5	11.8	6.0	31.6	24.1	45.2	12.7	5	-30	150	22	24	22350.0015
5	30	5.5	11.8	6.0	31.6	24.1	45.2	12.7	5	-30	150	22	24	22350.0016
5	35	5.5	11.8	6.0	31.6	24.1	45.2	12.7	5	-30	150	23	24	22350.0017
5	40	5.5	11.8	6.0	31.6	24.1	45.2	12.7	5	-30	150	24	24	22350.0018
5	45	5.5	11.8	6.0	31.6	24.1	45.2	12.7	5	-30	150	24	24	22350.0007

¹⁾ Shearing resistance similar to DIN 50141

d ₁ -0.04 -0.08	l ₁ +0.6	Dimensions							Location hole H11 [mm]	 min. max.		 [g]	Shearing resistance, two-shear ¹⁾ min. [kN]	Art. No.
		d ₂	d ₃	l ₂ ±1	l ₃	l ₄	l ₅	l ₆		[°C]				
		[mm]								[°C]				
5	50	5.5	11.8	6.0	31.6	24.1	45.2	12.7	5	-30	150	25	24	22350.0008
5	60	5.5	11.8	6.0	31.6	24.1	45.2	12.7	5	-30	150	27	24	22350.0009
5	70	5.5	11.8	6.0	31.6	24.1	45.2	12.7	5	-30	150	28	24	22350.0010
5	80	5.5	11.8	6.0	31.6	24.1	45.2	12.7	5	-30	150	30	24	22350.0011
6	10	7.0	11.8	7.0	31.6	24.1	45.2	12.7	6	-30	150	21	35	22350.0022
6	15	7.0	11.8	7.0	31.6	24.1	45.2	12.7	6	-30	150	21	35	22350.0023
6	20	7.0	11.8	7.0	31.6	24.1	45.2	12.7	6	-30	150	23	35	22350.0024
6	25	7.0	11.8	7.0	31.6	24.1	45.2	12.7	6	-30	150	23	35	22350.0025
6	30	7.0	11.8	7.0	31.6	24.1	45.2	12.7	6	-30	150	24	35	22350.0026
6	35	7.0	11.8	7.0	31.6	24.1	45.2	12.7	6	-30	150	26	35	22350.0027
6	40	7.0	11.8	7.0	31.6	24.1	45.2	12.7	6	-30	150	26	35	22350.0028
6	45	7.0	11.8	7.0	31.6	24.1	45.2	12.7	6	-30	150	27	35	22350.0029
6	50	7.0	11.8	7.0	31.6	24.1	45.2	12.7	6	-30	150	29	35	22350.0030
6	60	7.0	11.8	7.0	31.6	24.1	45.2	12.7	6	-30	150	30	35	22350.0019
6	70	7.0	11.8	7.0	31.6	24.1	45.2	12.7	6	-30	150	33	35	22350.0020
6	80	7.0	11.8	7.0	31.6	24.1	45.2	12.7	6	-30	150	34	35	22350.0021
8	10	9.5	14.7	8.2	35.8	26.9	51.5	15.8	8	-30	150	34	63	22350.0032
8	15	9.5	14.7	8.2	35.8	26.9	51.5	15.8	8	-30	150	36	63	22350.0033
8	20	9.5	14.7	8.2	35.8	26.9	51.5	15.8	8	-30	150	38	63	22350.0034
8	25	9.5	14.7	8.2	35.8	26.9	51.5	15.8	8	-30	150	39	63	22350.0035
8	30	9.5	14.7	8.2	35.8	26.9	51.5	15.8	8	-30	150	41	63	22350.0036
8	35	9.5	14.7	8.2	35.8	26.9	51.5	15.8	8	-30	150	43	63	22350.0037
8	40	9.5	14.7	8.2	35.8	26.9	51.5	15.8	8	-30	150	45	63	22350.0038
8	45	9.5	14.7	8.2	35.8	26.9	51.5	15.8	8	-30	150	47	63	22350.0039
8	50	9.5	14.7	8.2	35.8	26.9	51.5	15.8	8	-30	150	49	63	22350.0040
8	60	9.5	14.7	8.2	35.8	26.9	51.5	15.8	8	-30	150	52	63	22350.0031
8	70	9.5	14.7	8.2	35.8	26.9	51.5	15.8	8	-30	150	56	63	22350.0041
8	80	9.5	14.7	8.2	35.8	26.9	51.5	15.8	8	-30	150	60	63	22350.0042
8	90	9.5	14.7	8.2	35.8	26.9	51.5	15.8	8	-30	150	63	63	22350.0043
8	100	9.5	14.7	8.2	35.8	26.9	51.5	15.8	8	-30	150	67	63	22350.0051
10	15	12.0	14.7	9.6	35.8	26.9	51.5	15.8	10	-30	150	41	100	22350.0059
10	20	12.0	14.7	9.6	35.8	26.9	51.5	15.8	10	-30	150	44	100	22350.0044
10	25	12.0	14.7	9.6	35.8	26.9	51.5	15.8	10	-30	150	47	100	22350.0045
10	30	12.0	14.7	9.6	35.8	26.9	51.5	15.8	10	-30	150	50	100	22350.0046
10	35	12.0	14.7	9.6	35.8	26.9	51.5	15.8	10	-30	150	53	100	22350.0047
10	40	12.0	14.7	9.6	35.8	26.9	51.5	15.8	10	-30	150	56	100	22350.0048
10	45	12.0	14.7	9.6	35.8	26.9	51.5	15.8	10	-30	150	59	100	22350.0049
10	50	12.0	14.7	9.6	35.8	26.9	51.5	15.8	10	-30	150	62	100	22350.0050
10	60	12.0	14.7	9.6	35.8	26.9	51.5	15.8	10	-30	150	68	100	22350.0052
10	70	12.0	14.7	9.6	35.8	26.9	51.5	15.8	10	-30	150	74	100	22350.0053
10	80	12.0	14.7	9.6	35.8	26.9	51.5	15.8	10	-30	150	79	100	22350.0054
10	90	12.0	14.7	9.6	35.8	26.9	51.5	15.8	10	-30	150	85	100	22350.0055
10	100	12.0	14.7	9.6	35.8	26.9	51.5	15.8	10	-30	150	91	100	22350.0056
10	110	12.0	14.7	9.6	35.8	26.9	51.5	15.8	10	-30	150	97	100	22350.0057
10	120	12.0	14.7	9.6	35.8	26.9	51.5	15.8	10	-30	150	103	100	22350.0058
12	20	14.5	18.2	10.6	35.1	25.3	59.1	20.2	12	-30	150	69	144	22350.0064
12	25	14.5	18.2	10.6	35.1	25.3	59.1	20.2	12	-30	150	72	144	22350.0065
12	30	14.5	18.2	10.6	35.1	25.3	59.1	20.2	12	-30	150	77	144	22350.0066
12	35	14.5	18.2	10.6	35.1	25.3	59.1	20.2	12	-30	150	81	144	22350.0067
12	40	14.5	18.2	10.6	35.1	25.3	59.1	20.2	12	-30	150	85	144	22350.0068
12	45	14.5	18.2	10.6	35.1	25.3	59.1	20.2	12	-30	150	89	144	22350.0069
12	50	14.5	18.2	10.6	35.1	25.3	59.1	20.2	12	-30	150	94	144	22350.0070
12	60	14.5	18.2	10.6	35.1	25.3	59.1	20.2	12	-30	150	102	144	22350.0072
12	70	14.5	18.2	10.6	35.1	25.3	59.1	20.2	12	-30	150	111	144	22350.0074
12	80	14.5	18.2	10.6	35.1	25.3	59.1	20.2	12	-30	150	119	144	22350.0076
12	90	14.5	18.2	10.6	35.1	25.3	59.1	20.2	12	-30	150	127	144	22350.0060
12	100	14.5	18.2	10.6	35.1	25.3	59.1	20.2	12	-30	150	136	144	22350.0061
12	110	14.5	18.2	10.6	35.1	25.3	59.1	20.2	12	-30	150	146	144	22350.0062
12	120	14.5	18.2	10.6	35.1	25.3	59.1	20.2	12	-30	150	154	144	22350.0063

¹⁾ Shearing resistance similar to DIN 50141

d ₁ -0.04 -0.08	l ₁ +0.6	Dimensions							Location hole H11 [mm]	 min. max. [°C]		 [g]	Shearing resistance, two-shear ¹⁾ min. [kN]	Art. No.
		d ₂	d ₃	l ₂ ±1	l ₃	l ₄	l ₅	l ₆		[mm]				
16	30	19.0	23.4	14.0	42.2	29.8	74.8	24.7	16	-30	150	153	257	22350.0071
16	35	19.0	23.4	14.0	42.2	29.8	74.8	24.7	16	-30	150	161	257	22350.0073
16	40	19.0	23.4	14.0	42.2	29.8	74.8	24.7	16	-30	150	168	257	22350.0075
16	45	19.0	23.4	14.0	42.2	29.8	74.8	24.7	16	-30	150	172	257	22350.0077
16	50	19.0	23.4	14.0	42.2	29.8	74.8	24.7	16	-30	150	184	257	22350.0078
16	60	19.0	23.4	14.0	42.2	29.8	74.8	24.7	16	-30	150	200	257	22350.0079
16	70	19.0	23.4	14.0	42.2	29.8	74.8	24.7	16	-30	150	214	257	22350.0080
16	80	19.0	23.4	14.0	42.2	29.8	74.8	24.7	16	-30	150	231	257	22350.0081
16	90	19.0	23.4	14.0	42.2	29.8	74.8	24.7	16	-30	150	245	257	22350.0082
16	100	19.0	23.4	14.0	42.2	29.8	74.8	24.7	16	-30	150	260	257	22350.0083
16	110	19.0	23.4	14.0	42.2	29.8	74.8	24.7	16	-30	150	277	257	22350.0084
16	120	19.0	23.4	14.0	42.2	29.8	74.8	24.7	16	-30	150	293	257	22350.0085
16	130	19.0	23.4	14.0	42.2	29.8	74.8	24.7	16	-30	150	309	257	22350.0086
16	140	19.0	23.4	14.0	42.2	29.8	74.8	24.7	16	-30	150	324	257	22350.0087
16	150	19.0	23.4	14.0	42.2	29.8	74.8	24.7	16	-30	150	339	257	22350.0088
20	50	24.8	23.4	17.0	43.1	29.8	74.8	24.7	20	-30	150	245	403	22350.0089
20	60	24.8	23.4	17.0	43.1	29.8	74.8	24.7	20	-30	150	269	403	22350.0090
20	70	24.8	23.4	17.0	43.1	29.8	74.8	24.7	20	-30	150	293	403	22350.0091
20	80	24.8	23.4	17.0	43.1	29.8	74.8	24.7	20	-30	150	315	403	22350.0092
20	90	24.8	23.4	17.0	43.1	29.8	74.8	24.7	20	-30	150	340	403	22350.0093
20	100	24.8	23.4	17.0	43.1	29.8	74.8	24.7	20	-30	150	364	403	22350.0094
20	110	24.8	23.4	17.0	43.1	29.8	74.8	24.7	20	-30	150	390	403	22350.0095
20	120	24.8	23.4	17.0	43.1	29.8	74.8	24.7	20	-30	150	413	403	22350.0096
20	130	24.8	23.4	17.0	43.1	29.8	74.8	24.7	20	-30	150	436	403	22350.0097
20	140	24.8	23.4	17.0	43.1	29.8	74.8	24.7	20	-30	150	462	403	22350.0098
20	150	24.8	23.4	17.0	43.1	29.8	74.8	24.7	20	-30	150	487	403	22350.0099
25	50	31.0	30.4	22.0	54.8	37.5	88.7	33.2	25	-30	150	449	631	22350.0100
25	60	31.0	30.4	22.0	54.8	37.5	88.7	33.2	25	-30	150	487	631	22350.0101
25	70	31.0	30.4	22.0	54.8	37.5	88.7	33.2	25	-30	150	526	631	22350.0102
25	80	31.0	30.4	22.0	54.8	37.5	88.7	33.2	25	-30	150	559	631	22350.0103
25	90	31.0	30.4	22.0	54.8	37.5	88.7	33.2	25	-30	150	600	631	22350.0104
25	100	31.0	30.4	22.0	54.8	37.5	88.7	33.2	25	-30	150	640	631	22350.0001
25	110	31.0	30.4	22.0	54.8	37.5	88.7	33.2	25	-30	150	669	631	22350.0002
25	120	31.0	30.4	22.0	54.8	37.5	88.7	33.2	25	-30	150	713	631	22350.0003
25	130	31.0	30.4	22.0	54.8	37.5	88.7	33.2	25	-30	150	751	631	22350.0004
25	140	31.0	30.4	22.0	54.8	37.5	88.7	33.2	25	-30	150	788	631	22350.0005
25	150	31.0	30.4	22.0	54.8	37.5	88.7	33.2	25	-30	150	825	631	22350.0006

¹⁾ Shearing resistance similar to DIN 50141

Application example

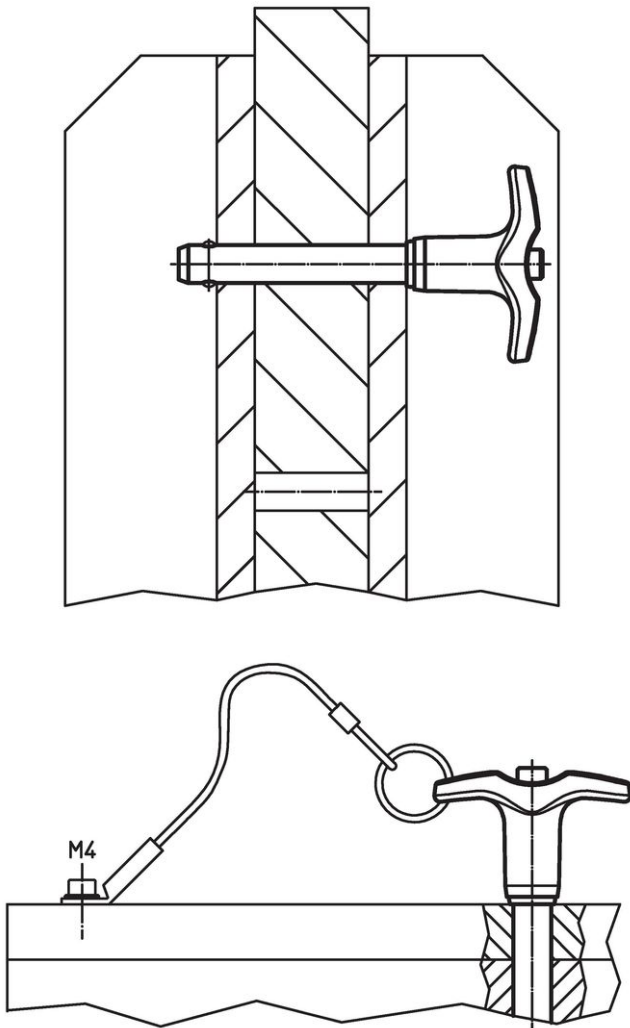

Compliance

RoHS compliant

Compliant according to Directive 2011/65/EU and Directive 2015/863.

Does not contain SVHC substances

No SVHC substances with more than 0.1% w/w contained - SVHC list [REACH] as of 27.06.2024.

Does not contain Proposition 65 substances

No Proposition 65 substances included.

<https://www.P65Warnings.ca.gov/>

Free from Conflict Minerals

This product does not contain any substances designated as "conflict minerals" such as tantalum, tin, gold or tungsten from the Democratic Republic of Congo or adjacent countries.