

Adjustable Clamping Levers · with screw

EH 24400.



Product Description

Adjustable clamping levers find versatile applications when the area of use is confined or a specific lever position is required.

Material

Lever

- Zinc die-cast, plastic coated, orange similar to RAL 2004, matt structure
- Zinc die-cast, plastic coated, silver, similar to RAL 9006, matt structure
- Zinc die-cast, plastic coated, black, similar to RAL 9005, matt structure

Inner parts

- Steel, blackened, quality 5.8

Screw

- Steel, blackened, quality 5.8

Operation

By lifting the lever the serrations are disengaged. The lever can be positioned by the serrations. On releasing the lever, the serrations are automatically re-engaged.

More information

Notes

The screw part can be exchanged.

Drawing



Order information

d_1	d_2	l_1	d_3	Dimensions					l_2	[g]	Art. No.
				h_1	h_2	h_3	h_4	[mm]			
orange											
13	M 4	12	10.0	24.5	4.0	3.5	30.5	30	27	24400.0010	
13	M 4	16	10.0	24.5	4.0	3.5	30.5	30	27	24400.0014	
13	M 4	20	10.0	24.5	4.0	3.5	30.5	30	28	24400.0018	
13	M 4	25	10.0	24.5	4.0	3.5	30.5	30	28	24400.0022	
13	M 4	32	10.0	24.5	4.0	3.5	30.5	30	28	24400.0026	
14	M 5	12	10.0	24.5	4.0	3.0	35.0	45	36	24400.0041	
14	M 5	16	10.0	24.5	4.0	3.0	35.0	45	36	24400.0051	
14	M 5	20	10.0	24.5	4.0	3.0	35.0	45	37	24400.0061	
14	M 5	25	10.0	24.5	4.0	3.0	35.0	45	38	24400.0071	
14	M 5	32	10.0	24.5	4.0	3.0	35.0	45	38	24400.0081	
14	M 5	40	10.0	24.5	4.0	3.0	35.0	45	39	24400.0086	
14	M 6	12	10.0	24.5	4.0	3.0	35.0	45	37	24400.0131	
14	M 6	16	10.0	24.5	4.0	3.0	35.0	45	37	24400.0141	
14	M 6	20	10.0	24.5	4.0	3.0	35.0	45	39	24400.0151	
14	M 6	25	10.0	24.5	4.0	3.0	35.0	45	41	24400.0161	
14	M 6	32	10.0	24.5	4.0	3.0	35.0	45	40	24400.0171	
14	M 6	40	10.0	24.5	4.0	3.0	35.0	45	41	24400.0181	
14	M 6	50	10.0	24.5	4.0	3.0	35.0	45	43	24400.0191	

d ₁	d ₂	l ₁	d ₃	Dimensions					l ₂		Art. No.
				h ₁	h ₂	h ₃	h ₄	[mm]			
18	M 6	16	13.5	31.0	6.5	3.0	45.0	62	72	24400.0221	
18	M 6	20	13.5	31.0	6.5	3.0	45.0	62	72	24400.0231	
18	M 6	25	13.5	31.0	6.5	3.0	45.0	62	74	24400.0241	
18	M 6	32	13.5	31.0	6.5	3.0	45.0	62	74	24400.0251	
18	M 6	40	13.5	31.0	6.5	3.0	45.0	62	76	24400.0261	
18	M 6	50	13.5	31.0	6.5	3.0	45.0	62	76	24400.0271	
18	M 6	63	13.5	31.0	6.5	3.0	45.0	62	80	24400.0281	
18	M 8	16	13.5	31.0	6.5	3.0	45.0	62	74	24400.0331	
18	M 8	20	13.5	31.0	6.5	3.0	45.0	62	76	24400.0341	
18	M 8	25	13.5	31.0	6.5	3.0	45.0	62	86	24400.0351	
18	M 8	32	13.5	31.0	6.5	3.0	45.0	62	86	24400.0361	
18	M 8	40	13.5	31.0	6.5	3.0	45.0	62	88	24400.0371	
18	M 8	50	13.5	31.0	6.5	3.0	45.0	62	89	24400.0381	
18	M 8	63	13.5	31.0	6.5	3.0	45.0	62	96	24400.0391	
22	M10	20	16.0	36.0	8.0	3.5	52.0	74	128	24400.0441	
22	M10	25	16.0	36.0	8.0	3.5	52.0	74	130	24400.0451	
22	M10	32	16.0	36.0	8.0	3.5	52.0	74	134	24400.0461	
22	M10	40	16.0	36.0	8.0	3.5	52.0	74	138	24400.0471	
22	M10	50	16.0	36.0	8.0	3.5	52.0	74	143	24400.0481	
22	M10	63	16.0	36.0	8.0	3.5	52.0	74	152	24400.0486	
22	M10	80	16.0	36.0	8.0	3.5	52.0	74	166	24400.0491	
25	M12	25	19.0	43.0	11.0	4.0	63.0	89	205	24400.0541	
25	M12	32	19.0	43.0	11.0	4.0	63.0	89	209	24400.0551	
25	M12	40	19.0	43.0	11.0	4.0	63.0	89	215	24400.0561	
25	M12	50	19.0	43.0	11.0	4.0	63.0	89	222	24400.0571	
25	M12	63	19.0	43.0	11.0	4.0	63.0	89	232	24400.0581	
25	M12	80	19.0	43.0	11.0	4.0	63.0	89	244	24400.0591	
30	M16	32	23.0	50.5	12.0	5.0	76.0	108	348	24400.0641	
30	M16	40	23.0	50.5	12.0	5.0	76.0	108	357	24400.0651	
30	M16	50	23.0	50.5	12.0	5.0	76.0	108	370	24400.0661	
30	M16	63	23.0	50.5	12.0	5.0	76.0	108	386	24400.0671	
30	M16	80	23.0	50.5	12.0	5.0	76.0	108	407	24400.0681	
silver											
14	M 5	12	10.0	24.5	4.0	3.0	35.0	45	36	24400.0043	
14	M 5	16	10.0	24.5	4.0	3.0	35.0	45	36	24400.0053	
14	M 5	20	10.0	24.5	4.0	3.0	35.0	45	37	24400.0063	
14	M 5	25	10.0	24.5	4.0	3.0	35.0	45	38	24400.0073	
14	M 5	32	10.0	24.5	4.0	3.0	35.0	45	38	24400.0083	
14	M 5	40	10.0	24.5	4.0	3.0	35.0	45	39	24400.0088	
14	M 6	12	10.0	24.5	4.0	3.0	35.0	45	37	24400.0133	
14	M 6	16	10.0	24.5	4.0	3.0	35.0	45	37	24400.0143	
14	M 6	20	10.0	24.5	4.0	3.0	35.0	45	39	24400.0153	
14	M 6	25	10.0	24.5	4.0	3.0	35.0	45	41	24400.0163	
14	M 6	32	10.0	24.5	4.0	3.0	35.0	45	40	24400.0173	
14	M 6	40	10.0	24.5	4.0	3.0	35.0	45	41	24400.0183	
14	M 6	50	10.0	24.5	4.0	3.0	35.0	45	43	24400.0193	
18	M 6	16	13.5	31.0	6.5	3.0	45.0	62	72	24400.0223	
18	M 6	20	13.5	31.0	6.5	3.0	45.0	62	72	24400.0233	
18	M 6	25	13.5	31.0	6.5	3.0	45.0	62	74	24400.0243	
18	M 6	32	13.5	31.0	6.5	3.0	45.0	62	74	24400.0253	
18	M 6	40	13.5	31.0	6.5	3.0	45.0	62	76	24400.0263	
18	M 6	50	13.5	31.0	6.5	3.0	45.0	62	76	24400.0273	
18	M 6	63	13.5	31.0	6.5	3.0	45.0	62	80	24400.0283	
18	M 8	16	13.5	31.0	6.5	3.0	45.0	62	74	24400.0333	
18	M 8	20	13.5	31.0	6.5	3.0	45.0	62	76	24400.0343	
18	M 8	25	13.5	31.0	6.5	3.0	45.0	62	86	24400.0353	
18	M 8	32	13.5	31.0	6.5	3.0	45.0	62	86	24400.0363	
18	M 8	40	13.5	31.0	6.5	3.0	45.0	62	88	24400.0373	
18	M 8	50	13.5	31.0	6.5	3.0	45.0	62	89	24400.0383	
18	M 8	63	13.5	31.0	6.5	3.0	45.0	62	96	24400.0393	
22	M10	20	16.0	36.0	8.0	3.5	52.0	74	128	24400.0443	
22	M10	25	16.0	36.0	8.0	3.5	52.0	74	130	24400.0453	

d ₁	d ₂	l ₁	d ₃	Dimensions					l ₂		Art. No.
				h ₁	h ₂	h ₃	h ₄	[mm]			
22	M10	32	16.0	36.0	8.0	3.5	52.0	74	134	24400.0463	
22	M10	40	16.0	36.0	8.0	3.5	52.0	74	138	24400.0473	
22	M10	50	16.0	36.0	8.0	3.5	52.0	74	143	24400.0483	
22	M10	63	16.0	36.0	8.0	3.5	52.0	74	152	24400.0488	
22	M10	80	16.0	36.0	8.0	3.5	52.0	74	166	24400.0493	
25	M12	25	19.0	43.0	11.0	4.0	63.0	89	205	24400.0543	
25	M12	32	19.0	43.0	11.0	4.0	63.0	89	209	24400.0553	
25	M12	40	19.0	43.0	11.0	4.0	63.0	89	215	24400.0563	
25	M12	50	19.0	43.0	11.0	4.0	63.0	89	222	24400.0573	
25	M12	63	19.0	43.0	11.0	4.0	63.0	89	232	24400.0583	
25	M12	80	19.0	43.0	11.0	4.0	63.0	89	244	24400.0593	
30	M16	32	23.0	50.5	12.0	5.0	76.0	108	348	24400.0643	
30	M16	40	23.0	50.5	12.0	5.0	76.0	108	357	24400.0653	
30	M16	50	23.0	50.5	12.0	5.0	76.0	108	370	24400.0663	
30	M16	63	23.0	50.5	12.0	5.0	76.0	108	386	24400.0673	
30	M16	80	23.0	50.5	12.0	5.0	76.0	108	407	24400.0683	
black											
13	M 4	12	10.0	24.5	4.0	3.5	30.5	30	27	24400.0012	
13	M 4	16	10.0	24.5	4.0	3.5	30.5	30	27	24400.0016	
13	M 4	20	10.0	24.5	4.0	3.5	30.5	30	28	24400.0020	
13	M 4	25	10.0	24.5	4.0	3.5	30.5	30	28	24400.0024	
13	M 4	32	10.0	24.5	4.0	3.5	30.5	30	28	24400.0028	
14	M 5	12	10.0	24.5	4.0	3.0	35.0	45	36	24400.0044	
14	M 5	16	10.0	24.5	4.0	3.0	35.0	45	36	24400.0054	
14	M 5	20	10.0	24.5	4.0	3.0	35.0	45	37	24400.0064	
14	M 5	25	10.0	24.5	4.0	3.0	35.0	45	38	24400.0074	
14	M 5	32	10.0	24.5	4.0	3.0	35.0	45	38	24400.0084	
14	M 5	40	10.0	24.5	4.0	3.0	35.0	45	39	24400.0089	
14	M 6	12	10.0	24.5	4.0	3.0	35.0	45	37	24400.0134	
14	M 6	16	10.0	24.5	4.0	3.0	35.0	45	37	24400.0144	
14	M 6	20	10.0	24.5	4.0	3.0	35.0	45	39	24400.0154	
14	M 6	25	10.0	24.5	4.0	3.0	35.0	45	41	24400.0164	
14	M 6	32	10.0	24.5	4.0	3.0	35.0	45	40	24400.0174	
14	M 6	40	10.0	24.5	4.0	3.0	35.0	45	41	24400.0184	
14	M 6	50	10.0	24.5	4.0	3.0	35.0	45	43	24400.0194	
18	M 6	16	13.5	31.0	6.5	3.0	45.0	62	72	24400.0224	
18	M 6	20	13.5	31.0	6.5	3.0	45.0	62	72	24400.0234	
18	M 6	25	13.5	31.0	6.5	3.0	45.0	62	74	24400.0244	
18	M 6	32	13.5	31.0	6.5	3.0	45.0	62	74	24400.0254	
18	M 6	40	13.5	31.0	6.5	3.0	45.0	62	76	24400.0264	
18	M 6	50	13.5	31.0	6.5	3.0	45.0	62	76	24400.0274	
18	M 6	63	13.5	31.0	6.5	3.0	45.0	62	80	24400.0284	
18	M 8	16	13.5	31.0	6.5	3.0	45.0	62	74	24400.0334	
18	M 8	20	13.5	31.0	6.5	3.0	45.0	62	76	24400.0344	
18	M 8	25	13.5	31.0	6.5	3.0	45.0	62	86	24400.0354	
18	M 8	32	13.5	31.0	6.5	3.0	45.0	62	86	24400.0364	
18	M 8	40	13.5	31.0	6.5	3.0	45.0	62	88	24400.0374	
18	M 8	50	13.5	31.0	6.5	3.0	45.0	62	89	24400.0384	
18	M 8	63	13.5	31.0	6.5	3.0	45.0	62	96	24400.0394	
22	M10	20	16.0	36.0	8.0	3.5	52.0	74	128	24400.0444	
22	M10	25	16.0	36.0	8.0	3.5	52.0	74	130	24400.0454	
22	M10	32	16.0	36.0	8.0	3.5	52.0	74	134	24400.0464	
22	M10	40	16.0	36.0	8.0	3.5	52.0	74	138	24400.0474	
22	M10	50	16.0	36.0	8.0	3.5	52.0	74	143	24400.0484	
22	M10	63	16.0	36.0	8.0	3.5	52.0	74	152	24400.0489	
22	M10	80	16.0	36.0	8.0	3.5	52.0	74	166	24400.0494	
25	M12	25	19.0	43.0	11.0	4.0	63.0	89	205	24400.0544	
25	M12	32	19.0	43.0	11.0	4.0	63.0	89	209	24400.0554	
25	M12	40	19.0	43.0	11.0	4.0	63.0	89	215	24400.0564	
25	M12	50	19.0	43.0	11.0	4.0	63.0	89	222	24400.0574	
25	M12	63	19.0	43.0	11.0	4.0	63.0	89	232	24400.0584	
25	M12	80	19.0	43.0	11.0	4.0	63.0	89	244	24400.0594	

d ₁	d ₂	l ₁	d ₃	Dimensions					l ₂	[g]	Art. No.
				h ₁	h ₂	h ₃	h ₄	[mm]			
30	M16	32	23.0	50.5	12.0	5.0	76.0	108	348	24400.0644	
30	M16	40	23.0	50.5	12.0	5.0	76.0	108	357	24400.0654	
30	M16	50	23.0	50.5	12.0	5.0	76.0	108	370	24400.0664	
30	M16	63	23.0	50.5	12.0	5.0	76.0	108	386	24400.0674	
30	M16	80	23.0	50.5	12.0	5.0	76.0	108	407	24400.0684	

Application example

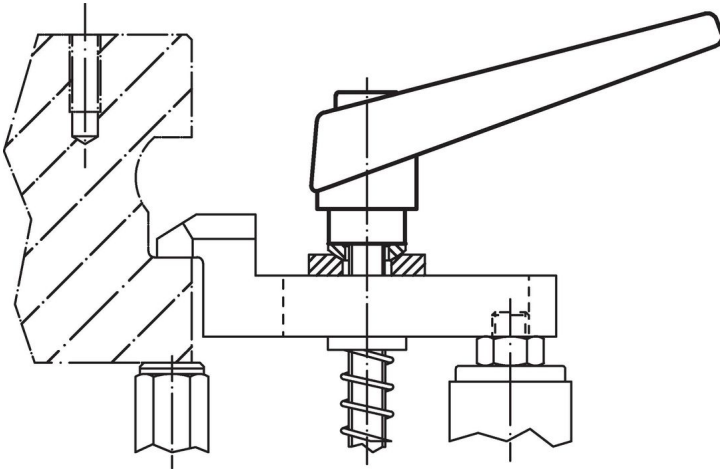

Compliance

RoHS compliant

Contains lead - compliant according to exceptions 6a / 6b / 6c.

Contains SVHC substances >0,1% w/w

Contains lead - SVHC list [REACH] as of 27.06.2024.

Contains Proposition 65 substances



Lead can cause cancer and reproductive harm from exposure
<https://www.P65Warnings.ca.gov/>

Free from Conflict Minerals

This product does not contain any substances designated as "conflict minerals" such as tantalum, tin, gold or tungsten from the Democratic Republic of Congo or adjacent countries.