

Base Plates • suitable on pallets DIN 55 201

1000.800



Product Description

Material

- Steel, hardened, ground

More information

Notes

Special types on request.

Drawing

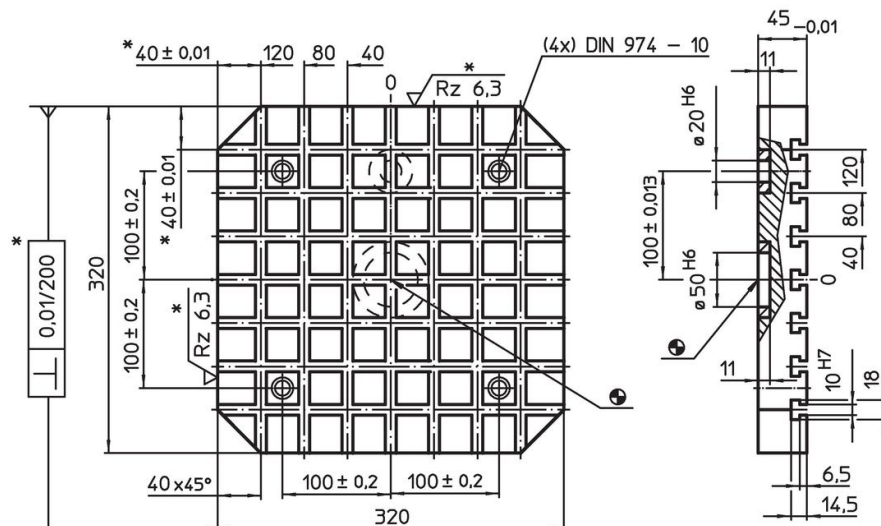

* These tolerances are valid only for optional exterior stop type.
Slot spacing $40 \pm 0,01$.

Order information

System	Dimensions									y [mm]	Number of T-slots	[kg]	Art. No.
	a	b ₁	b ₂	b ₃	c	d	l ₁	l ₂	l ₃				
V40	100	320	100	40	40	20	320	100	40	10	7 x 7	28	1000.800

Application example

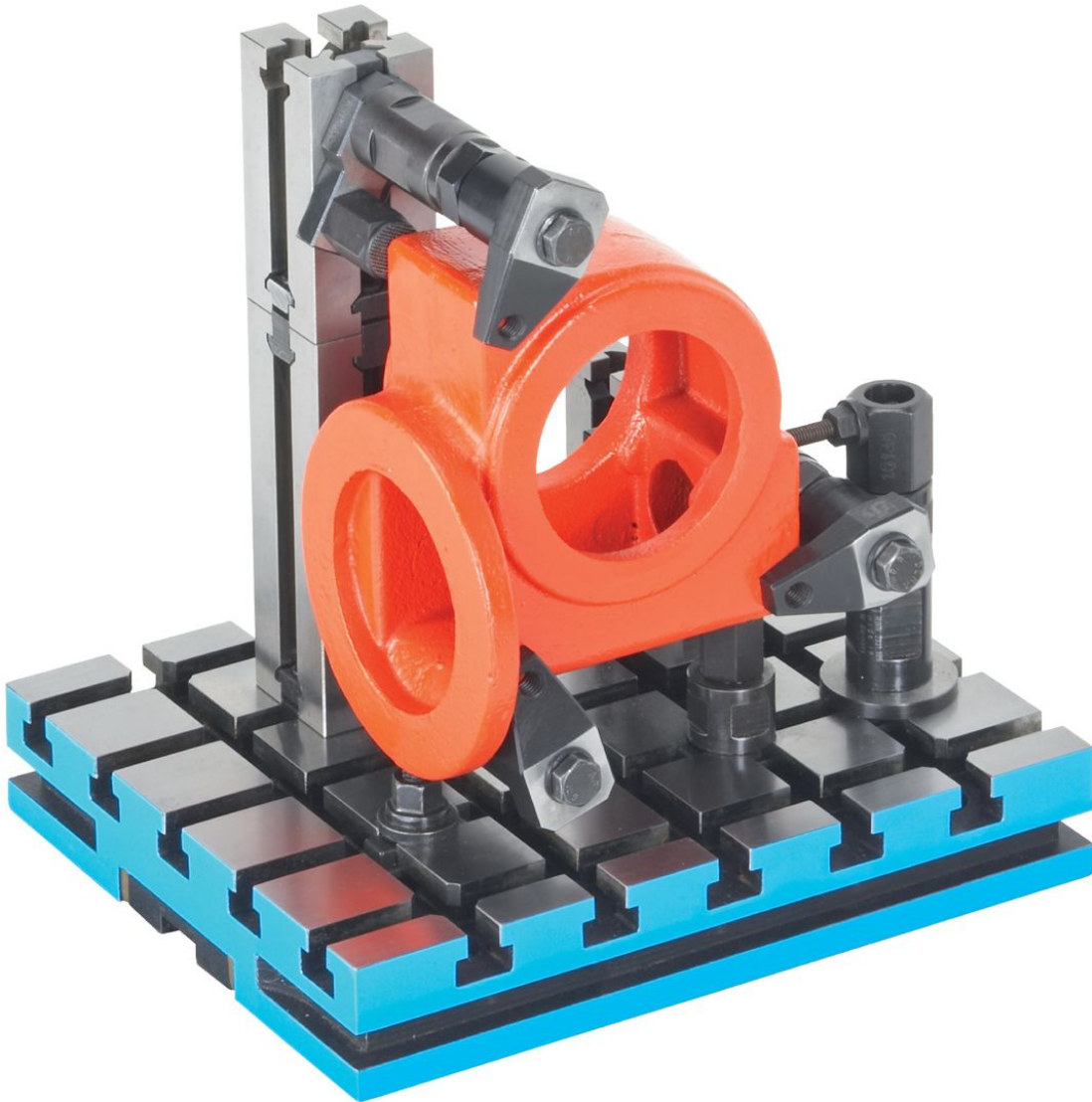



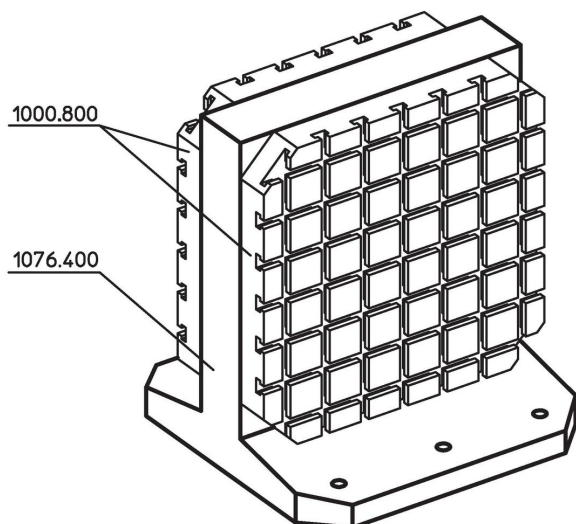

Compliance

RoHS compliant

Compliant according to Directive 2011/65/EU and Directive 2015/863.

Does not contain SVHC substances

No SVHC substances with more than 0.1% w/w contained - SVHC list [REACH] as of 27.06.2024.

Does not contain Proposition 65 substances

No Proposition 65 substances included.

<https://www.P65Warnings.ca.gov/>

Free from Conflict Minerals

This product does not contain any substances designated as "conflict minerals" such as tantalum, tin, gold or tungsten from the Democratic Republic of Congo or adjacent countries.