

Clamping Angles

1076.400



Product Description

Material

- Aluminium Al

More information

Notes

Special types on request.

Further products

- Threaded Lifting Pins, self-locking

Drawing

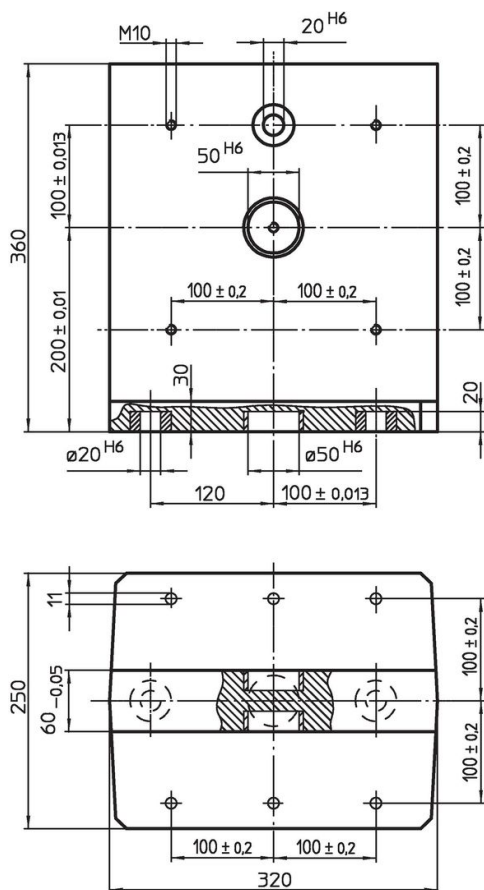

Order information

System	 [kg]	Art. No.
V40	22	1076.400

Application example

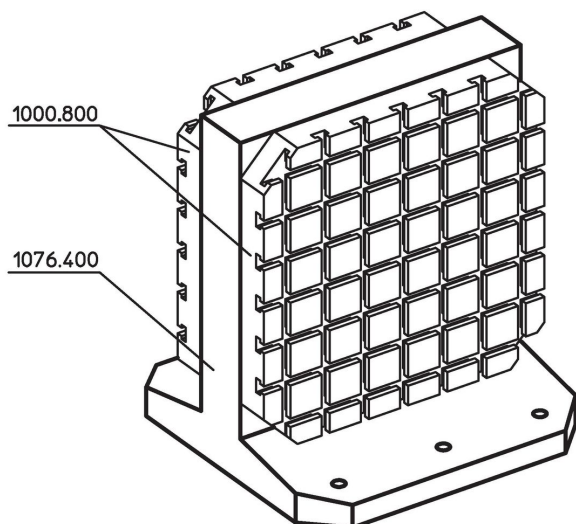

Compliance

RoHS compliant

Contains lead - compliant according to exceptions 6a / 6b / 6c.

Contains SVHC substances >0,1% w/w

Contains lead - SVHC list [REACH] as of 27.06.2024.

Contains Proposition 65 substances



Lead can cause cancer and reproductive harm from exposure
<https://www.P65Warnings.ca.gov/>

Free from Conflict Minerals

This product does not contain any substances designated as "conflict minerals" such as tantalum, tin, gold or tungsten from the Democratic Republic of Congo or adjacent countries.