

V-Blocks
1548.100

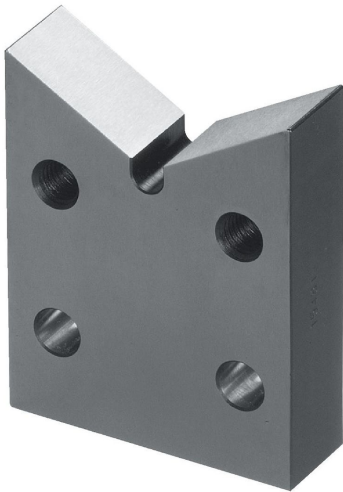

Product Description

Material

- Steel, case-hardened, ground

Drawing

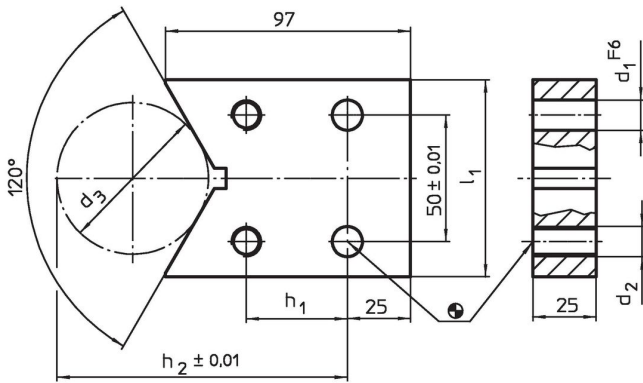

Order information

System	Dimensions								[g]	Art. No.
	l_1	h_1	h_2	d_1	d_2	d_3	d_3 min.	d_3 max.		
L12	78	40	115	12	M12	60	18	148	1249	1548.100

Application example

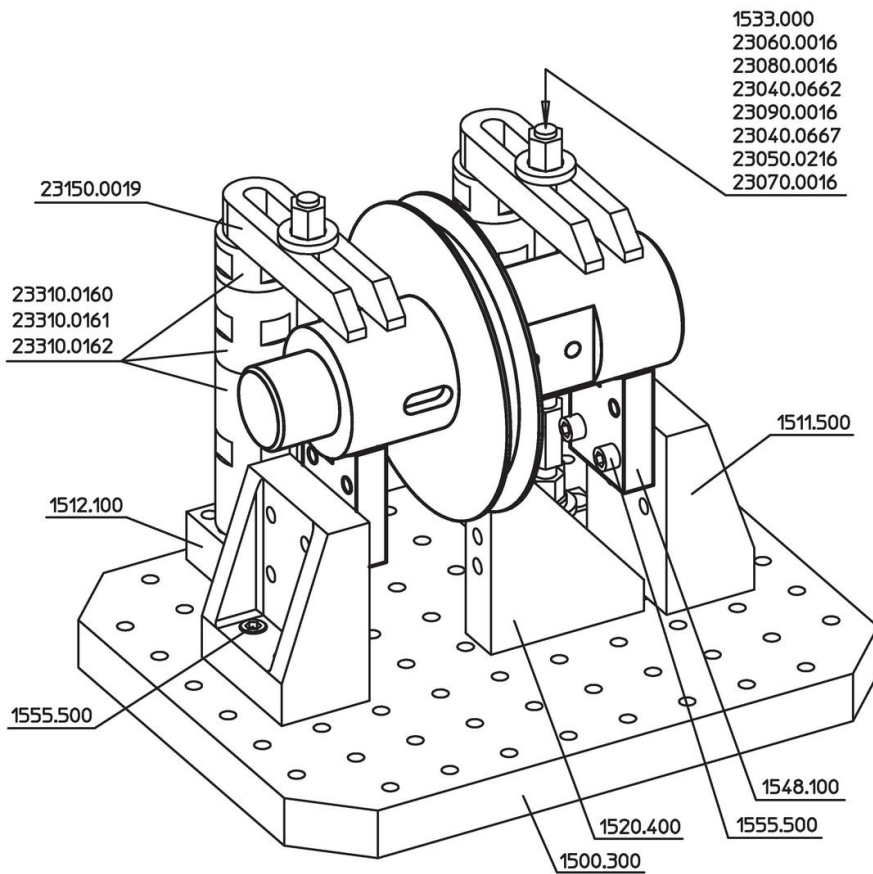

Compliance

RoHS compliant

Compliant according to Directive 2011/65/EU and Directive 2015/863.

Does not contain SVHC substances

No SVHC substances with more than 0.1% w/w contained - SVHC list [REACH] as of 23.01.2024.

Does not contain Proposition 65 substances

No Proposition 65 substances included.

<https://www.P65Warnings.ca.gov/>

Free from Conflict Minerals

This product does not contain any substances designated as "conflict minerals" such as tantalum, tin, gold or tungsten from the Democratic Republic of Congo or adjacent countries.