

Index Plungers Mini Indexes • Stainless steel

22110.1114



Product Description

Particularly suitable for screwing into thin walled pieces.
Performance in the smallest space requirements.
Due to a thread recess the index plungers can be completely screwed in.

Material

Body

- Stainless steel 1.4305

Locking pin

- Stainless steel 1.4305

Knob

- Stainless steel 1.4308

Assembly

Screw in the mini index. By lifting the knob, the hexagon will be released for assembly.
The screw length can be adapted by distance collars for index plungers (EH 22120.).

Operation

When using the self-locking type the knob is pulled-out, turned 30° and secured by a notched catch.

More information

Notes

Knob not removable.

Further products

- Distance Collars, for index plungers

Drawing

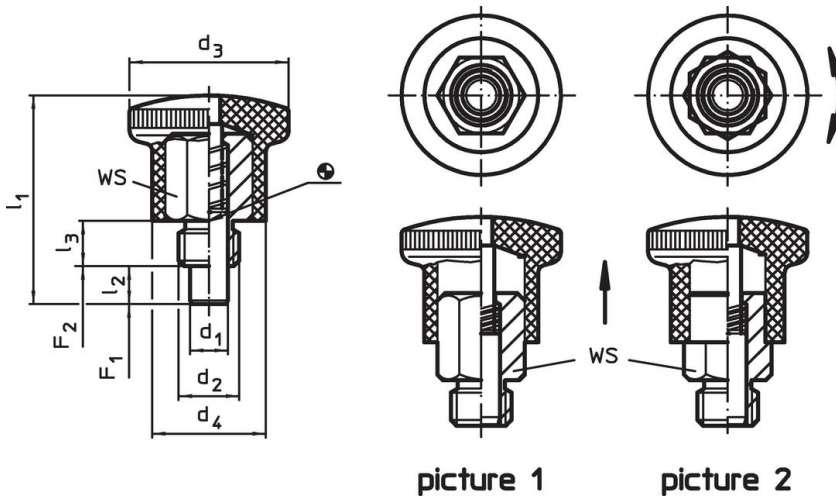

Order information

Dimensions							WS	Spring load ¹⁾		max.	[g]	Art. No.
d ₁ h9	d ₂	d ₃	d ₄	l ₁	l ₂ min.	l ₃		F ₁ ~	F ₂ ~			
[mm]							[mm]	[N]				
without locking – picture 1												
6	M12	28	20	40.5	7	10	14	10	23	250	74	22110.1114

¹⁾ statistical average value

Application example



Compliance

RoHS compliant

Compliant according to Directive 2011/65/EU and Directive 2015/863.

Does not contain SVHC substances

No SVHC substances with more than 0.1% w/w contained - SVHC list [REACH] as of 27.06.2024.

Does not contain Proposition 65 substances

No Proposition 65 substances included.

<https://www.P65Warnings.ca.gov/>

Free from Conflict Minerals

This product does not contain any substances designated as "conflict minerals" such as tantalum, tin, gold or tungsten from the Democratic Republic of Congo or adjacent countries.