

Index Bolts • with mounting flange

22120.0376



Product Description

Index bolts are used for indexing purposes.
Plastic cover for grip allows better handling.

Material

Body

- Steel, blackened

Locking pin

- Steel, nitrided, black

Assembly

Right and left mounting is possible due to countersinks on both sides.
Index bolt for lateral fastening.

Operation

By turning the index bolt 180° the locking pin will be pulled-in and secured by a notched catch (when locking pin should not overhang).

More information

Further products

- Locating Bushings, for index bolts and index plungers

Drawing

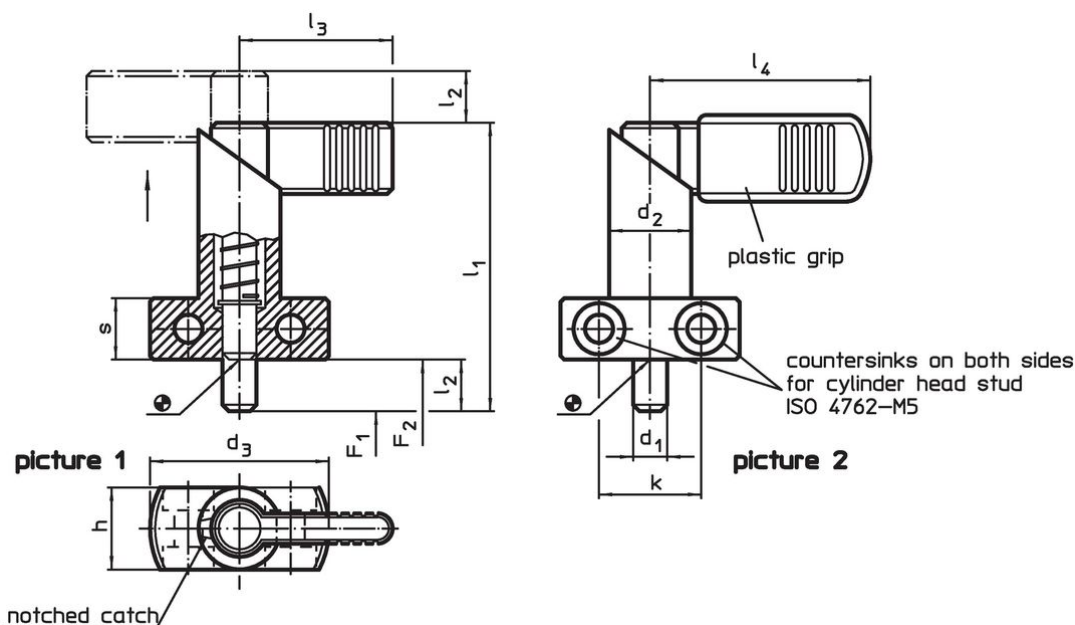

Order information

Dimensions									Spring load ¹⁾		max.		Art. No.
d_1	l_2	d_2	d_3	h	k	l_1	l_3	s	F_1	F_2			
0 -0.05									~	~			
[mm]									[N]		[°C]	[g]	
without plastic cover for grip – picture 1													
6	10	16	35	16	20	56	32	12	12	32	250	82	22120.0376

¹⁾ statistical average value

Application example



Compliance

RoHS compliant

Contains lead - compliant according to exceptions 6a / 6b / 6c.

Contains SVHC substances >0,1% w/w

Contains lead - SVHC list [REACH] as of 27.06.2024.

Contains Proposition 65 substances



Lead can cause cancer and reproductive harm from exposure
<https://www.P65Warnings.ca.gov/>

Free from Conflict Minerals

This product does not contain any substances designated as "conflict minerals" such as tantalum, tin, gold or tungsten from the Democratic Republic of Congo or adjacent countries.