

Index Plungers · with mounting flange

22120.0939



Product Description

Index plungers are used for indexing bores.
For fixing onto thin walled parts.
The small dimensions are a feature of these index plungers.

Material

Flange

- Zinc die-cast, zinc-plated by galvanization

Locking pin

- Steel, hardened

Knob

- Thermoplastic PA 6, black, dull

Operation

When using locking index plungers the knob is pulled out and turned 90°.

More information

Notes

Knob not removable.

Further products

- Locating Bushings, for index bolts and index plungers

Drawing

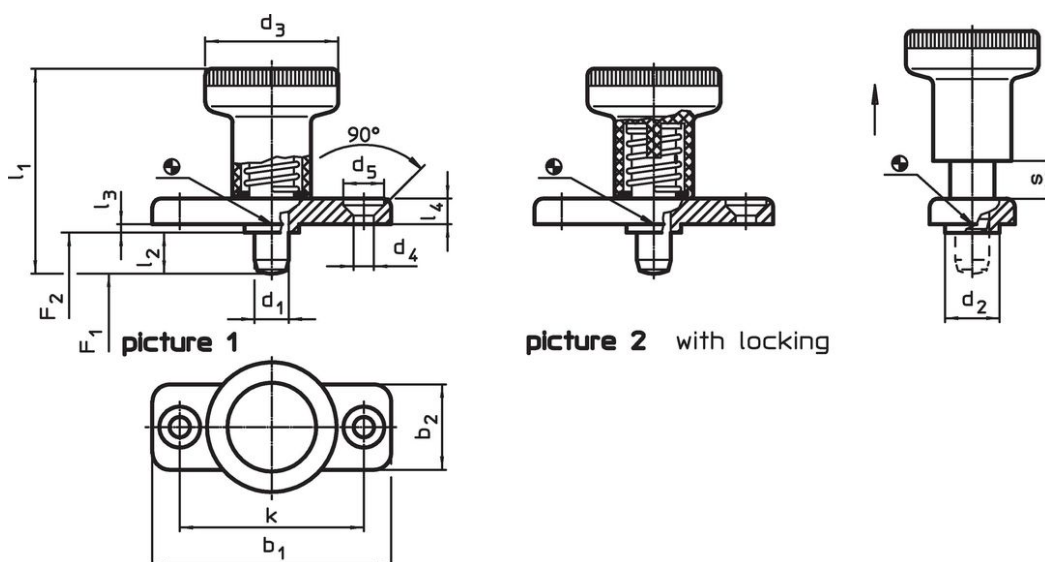

Order information

Dimensions													Spring load ¹⁾		Temperature		Weight [g]	Art. No. ²⁾
d ₁	l ₂	b ₁	b ₂	d ₂	d ₃	d ₄	d ₅	k	l ₁	l ₃	l ₄	s	F ₁	F ₂	min.	max.		
-0.02				-0.02						-0.15				~	~			
-0.05				-0.1										[N]	[N]	[°C]	[°C]	
with locking – picture 2, Steel																		
8	18	46	20	12	31	5.3	10.4	34	54	2.5	5.5	8	15.5	28	-30	80	63	22120.0939

¹⁾ statistical average value

²⁾ Locking pin is not completely retractable

Application example



Compliance

RoHS compliant

Contains lead - compliant according to exceptions 6a / 6b / 6c.

Contains SVHC substances >0,1% w/w

Contains lead - SVHC list [REACH] as of 27.06.2024.

Contains Proposition 65 substances



Lead can cause cancer and reproductive harm from exposure
<https://www.P65Warnings.ca.gov/>

Free from Conflict Minerals

This product does not contain any substances designated as "conflict minerals" such as tantalum, tin, gold or tungsten from the Democratic Republic of Congo or adjacent countries.