

Eccentric Mounting Bushings • for lateral plungers, smooth

22150.0812



Product Description

The eccentric mounting bushing is used in conjunction with smooth lateral plungers EH 22150. for positioning or clamping workpieces with large tolerances.

Material

Body

- Steel, blackened

Assembly

Mounting and position determination by means of clamping with threaded pin.

Drawing

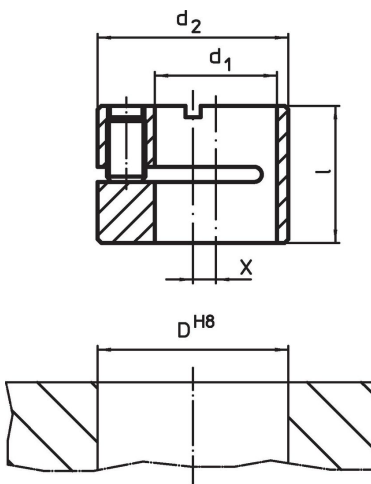

Order information

d ₁ H8	d ₂ h9	Dimensions		x	Location hole D H8 [mm]	[g]	Art. No.
		l	[mm]				
12	18	13.9		2	18	13	22150.0812

Application example



Compliance

RoHS compliant

Compliant according to Directive 2011/65/EU and Directive 2015/863.

Does not contain SVHC substances

No SVHC substances with more than 0.1% w/w contained - SVHC list [REACH] as of 27.06.2024.

Does not contain Proposition 65 substances

No Proposition 65 substances included.

<https://www.P65Warnings.ca.gov/>

Free from Conflict Minerals

This product does not contain any substances designated as "conflict minerals" such as tantalum, tin, gold or tungsten from the Democratic Republic of Congo or adjacent countries.