

Mounting Pads

22590.0110



Product Description

Mounting pads can be used as foot or thrust pad. Not parallel bearing surfaces up to 15° degrees can be compensated.

Material

Ball element

- Stainless steel 1.4305

Pad

- Thermoplastic POM, white

More information

Notes

For the versions $d_1 = M10$ and $M12$ the lock nut conforms to DIN 934.

Drawing

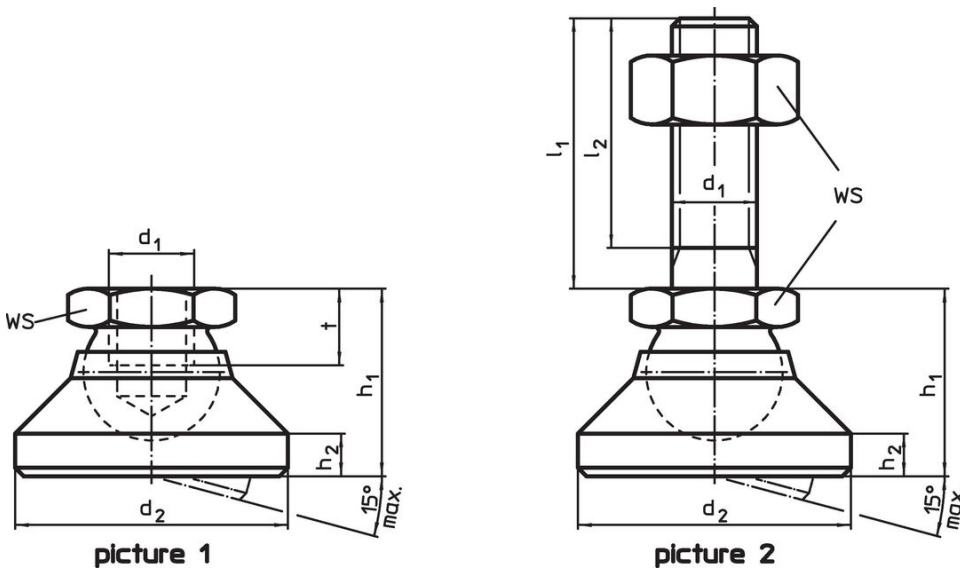

Order information

Dimensions					WS	Load capacity for static load max.	Temperature		Weight	Art. No.
d_1	d_2	h_1	h_2	t			min.	max.		
[mm]					[mm]	[kN]	[°C]			
pad from thermoplastic, ball element from stainless steel – picture 1, Thermoplastic										
M10	32	22	5	9	17	10	-30	80	26	22590.0110

Application example



Compliance

RoHS compliant

Compliant according to Directive 2011/65/EU and Directive 2015/863.

Does not contain SVHC substances

No SVHC substances with more than 0.1% w/w contained - SVHC list [REACH] as of 27.06.2024.

Does not contain Proposition 65 substances

No Proposition 65 substances included.

<https://www.P65Warnings.ca.gov/>

Free from Conflict Minerals

This product does not contain any substances designated as "conflict minerals" such as tantalum, tin, gold or tungsten from the Democratic Republic of Congo or adjacent countries.