

Fulcrum Screws

22591.0008



Product Description

Can be used as screw-in foot or thrust pad.
Compact design for simple levelling by means of the spanner flat at the bushing or preferably by means of an internal hexagon.

Material

Body

- Heat-treated steel, tempered, blackened

Ball element

- Heat-treated steel, tempered, blackened

More information

Notes

The fulcrum screws may exclusively be exposed to static loading.

Drawing

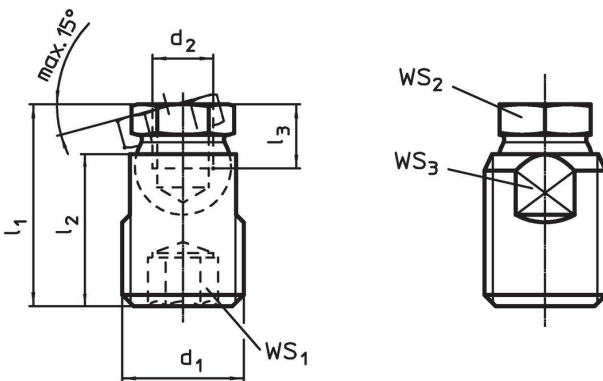

Order information

d ₁	d ₂	Dimensions			WS ₁	WS ₂	WS ₃	Load capacity for static load max.	🔩 [g]	Art. No.
		l ₁ ±0.5 [mm]	l ₂	l ₃ min.						
Steel										
M16	M8	26.5	20	7	8	12	14	18	24	22591.0008

Application example

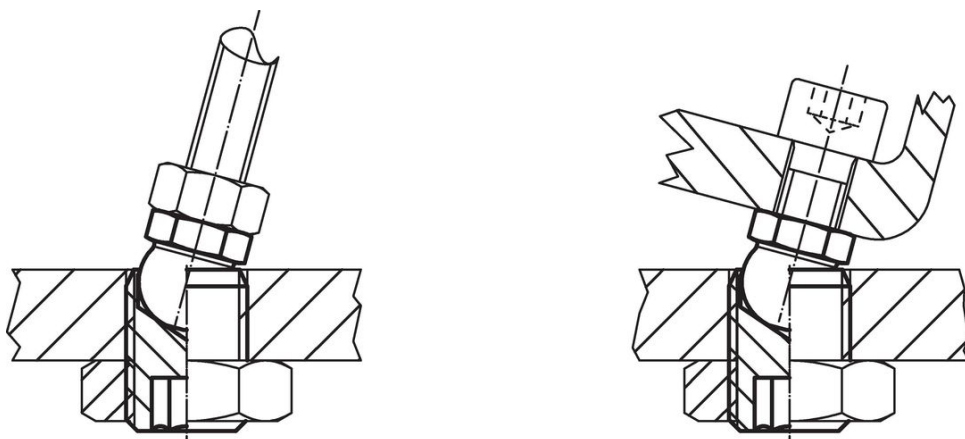

Compliance

RoHS compliant

Contains lead - compliant according to exceptions 6a / 6b / 6c.

Contains SVHC substances >0,1% w/w

Contains lead - SVHC list [REACH] as of 27.06.2024.

Contains Proposition 65 substances



Lead can cause cancer and reproductive harm from exposure
<https://www.P65Warnings.ca.gov/>

Free from Conflict Minerals

This product does not contain any substances designated as "conflict minerals" such as tantalum, tin, gold or tungsten from the Democratic Republic of Congo or adjacent countries.