

## Support Legs • protected against slipping

22593.0320



### Product Description

The support legs are universally usable as adjustable legs.

In this version with a rubber cap, sensitive support surfaces are protected, and slipping is prevented.

The plate is screwed to the threaded pin and nut by a stainless steel fastening screw, and is also glued.

### Material

#### Grub Screw

- Steel, zinc-plated by galvanization, passivated

#### Rubber cap

- Rubber, black

#### Lock nut

- Steel, zinc-coated by galvanisation, passivated, ISO 4032

#### Pad

- Steel, zinc-plated by galvanization, passivated

### More information

#### Further products

- Support Legs

### Drawing



picture 1

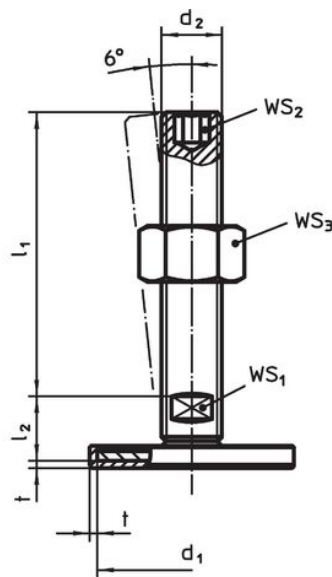

picture 2



picture 3

### Order information

d <sub>1</sub>	d <sub>2</sub>	Dimensions			WS <sub>1</sub> [mm]	WS <sub>3</sub> [mm]	[g]	Art. No.
		l <sub>1</sub> [mm]	l <sub>2</sub>	t				
with screw – picture 1, Steel								
40	M10	50	11	1.5	17	16	65	22593.0320

## Compliance

### RoHS compliant

Contains lead - compliant according to exceptions 6a / 6b / 6c.

### Contains SVHC substances >0,1% w/w

Contains lead - SVHC list [REACH] as of 27.06.2024.

### Contains Proposition 65 substances



Lead can cause cancer and reproductive harm from exposure  
<https://www.P65Warnings.ca.gov/>

### Free from Conflict Minerals

This product does not contain any substances designated as "conflict minerals" such as tantalum, tin, gold or tungsten from the Democratic Republic of Congo or adjacent countries.