

Ball Casters • plastic

22751.0115

No Photo
available

Product Description

Ball casters are module for transport systems, conveyances, to working and packing facilities. For example, parts can be easily moved, turned and controlled.

Thanks to the technical properties of the plastic, the component does not require maintenance or lubrication and is also resistant to abrasion. In contrast to the steel model, the plastic model offers additional benefits such as electrical insulation and anti-magnetic characteristics thanks to the properties of its material.

Material

Cap

- Plastic, white

Housing

- Plastic, white

Ball

- Thermoplastic POM, white

Bearing ball

- Stainless steel

Drawing

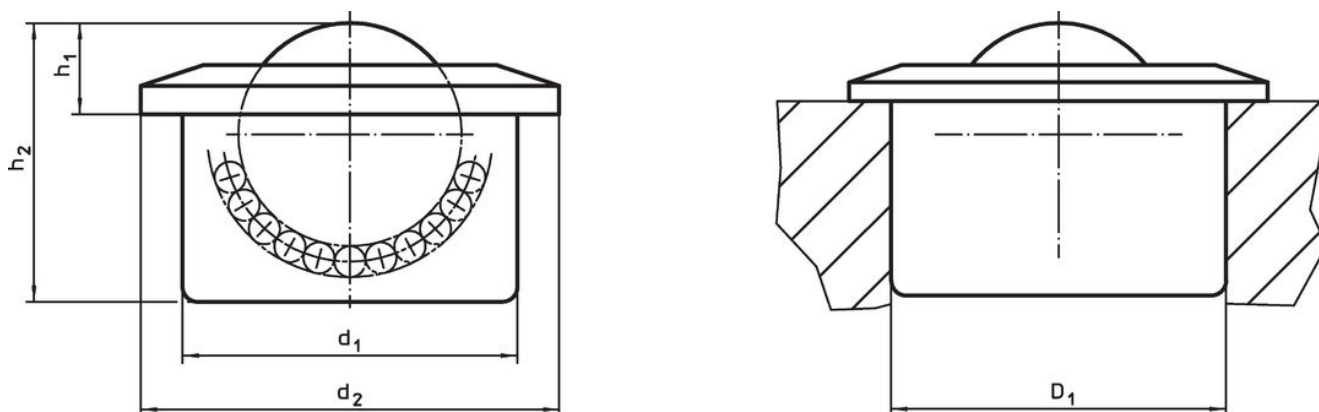

Order information

Dimensions					Location hole D ₁ H7 [mm]	Dynamic carrying figure C [N]	Temperature range		Weight [g]	Art. No.
d ₁	Ball diameter	d ₂	h ₁	h ₂			min.	max.		
[mm]							[°C]			
Bearing ball: Stainless steel										
24	16	31	9.8	21	23.95	300	-40	80	11	22751.0115

Compliance

RoHS compliant

Compliant according to Directive 2011/65/EU and Directive 2015/863.

Does not contain SVHC substances

No SVHC substances with more than 0.1% w/w contained - SVHC list [REACH] as of 27.06.2024.

Does not contain Proposition 65 substances

No Proposition 65 substances included.

<https://www.P65Warnings.ca.gov/>

Free from Conflict Minerals

This product does not contain any substances designated as "conflict minerals" such as tantalum, tin, gold or tungsten from the Democratic Republic of Congo or adjacent countries.