

Thrust Screws • with brass pad

22760.0124



Product Description

Thrust screws can be used for a gentle clamping or pressing of thread spindles, axes, shafts and surface treated parts.

Material

Pad

- Brass

Screw

- Heat-treated steel, 1200 ±100 N/mm²

More information

Further products

- Thrust Screws, with plastic pad

Drawing

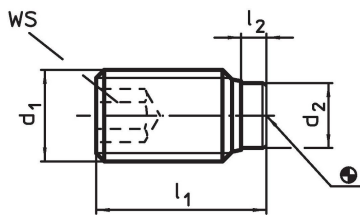

Order information

Dimensions				WS	max.		Art. No.
d ₁	l ₁	l ₂	d ₂	[mm]	[°C]	[g]	
Heat-treated steel							
[mm]	[mm]	[mm]	[mm]	[mm]	[°C]	[g]	
M12	22.5	3.4	8.5	6	250	12	22760.0124

Application example

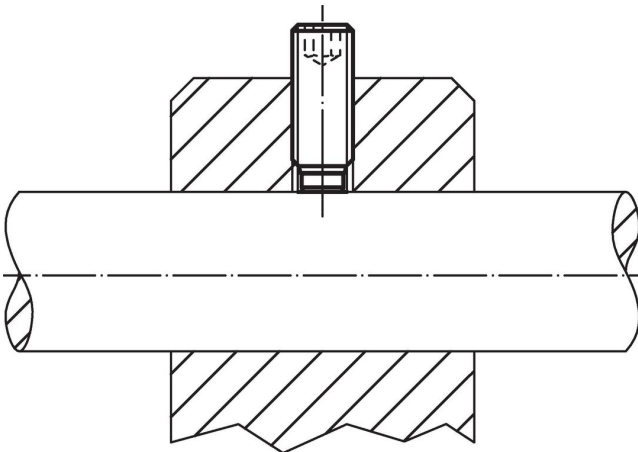

Compliance

RoHS compliant

Contains lead - compliant according to exceptions 6a / 6b / 6c.

Contains SVHC substances >0,1% w/w

Contains lead - SVHC list [REACH] as of 23.01.2024.

Contains Proposition 65 substances



Lead can cause cancer and reproductive harm from exposure
<https://www.P65Warnings.ca.gov/>

Free from Conflict Minerals

This product does not contain any substances designated as "conflict minerals" such as tantalum, tin, gold or tungsten from the Democratic Republic of Congo or adjacent countries.