

## Radio Transmitters • for retrieval unit

22810.9010



### Product Description

For cable-free transfer of the retrieval signal.  
The radio transmitter is installed close to the retrieval unit, and connected to the bushing of the silicone cable. The transmitter makes the polled signal available by radio, and does not require additional cable connection. Power is supplied by a battery.  
The radio transmitter meets the requirements of protection class IP 67 (robust material) and is therefore suitable for use with cooling lubricants.  
Frequency: 868.3 MHz (EU, Switzerland)  
Other frequencies available on request.

### More information

#### Notes

An AA battery (3.6 V) is included in the scope of delivery.  
Further information on request.

#### Further products

- Radio Receivers, for retrieval unit

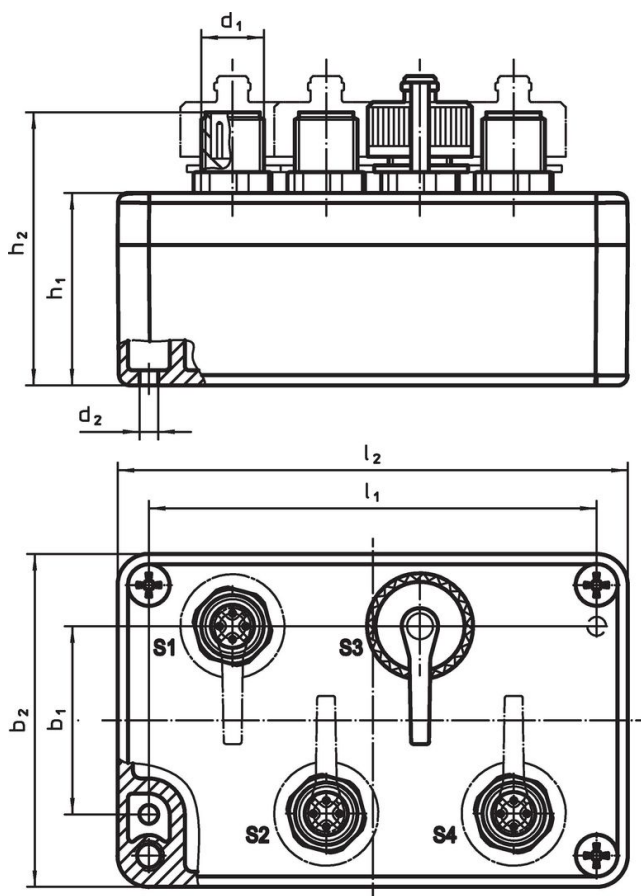

### Drawing



### Order information

Dimensions									For art. no.	[g]	Art. No.
$l_2$	$b_2$	$h_2$	$b_1$	$d_1$	$d_2$	$h_1$	$l_1$				
[mm]											
universal radio transmitter with protective caps											
98	64	52.5	36	M12 x 1	4.5	37	86	22810.0008 / .0012	288	22810.9010	

**Accessories**

	 [g]	Art. No.
<b>protection cap</b>		
	4.9	<b>22810.9011</b>

**Compliance**

**RoHS compliant**

Compliant according to Directive 2011/65/EU and Directive 2015/863.

**Does not contain SVHC substances**

No SVHC substances with more than 0.1% w/w contained - SVHC list [REACH] as of 27.06.2024.

**Does not contain Proposition 65 substances**

No Proposition 65 substances included.

<https://www.P65Warnings.ca.gov/>

**Free from Conflict Minerals**

This product does not contain any substances designated as "conflict minerals" such as tantalum, tin, gold or tungsten from the Democratic Republic of Congo or adjacent countries.