

Fixture Nuts • DIN 6330 (height 1,5 d)

23070.0022



Product Description

Fixture nuts according to DIN 6330 have a spherical surface to match conical seats DIN 6319 (EH 23050.).

With this combination of fixture nut and conical seat, non-parallel clamping surfaces can be compensated.

Material

- Heat-treated steel, tempered, quality 10, phosphated

More information

References

For torques and strengths please refer to appendix - Technical Data -

Drawing



Order information

d ₁	d ₂	Dimensions				[g]	Art. No. ¹⁾
		e	m	r	s		
with lateral spherical bearing surface, form B, Heat-treated steel							
M22	24	39.3	33	29	34	162	23070.0022

¹⁾ DIN standards do not include these dimensions.

Application example

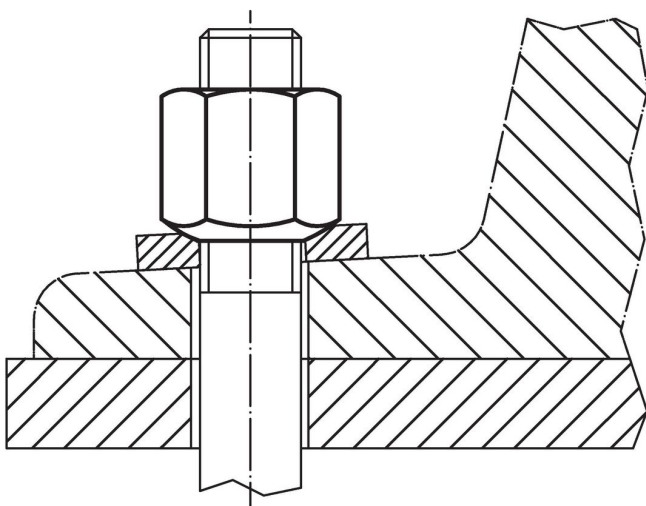

Compliance

RoHS compliant

Compliant according to Directive 2011/65/EU and Directive 2015/863.

Does not contain SVHC substances

No SVHC substances with more than 0.1% w/w contained - SVHC list [REACH] as of 27.06.2024.

Does not contain Proposition 65 substances

No Proposition 65 substances included.

<https://www.P65Warnings.ca.gov/>

Free from Conflict Minerals

This product does not contain any substances designated as "conflict minerals" such as tantalum, tin, gold or tungsten from the Democratic Republic of Congo or adjacent countries.