

Stabilizing Clamping Jaws

23240.0012



Product Description

Due to the big clamping jaw, this clamping element is suitable for lateral clamping of high workpieces. The clamping force acts forwards and downwards. Clamping plate is turnable, i.e. to the ground or ribbed side.

Material

Body

- Cast iron

Clamping jaws

- Steel, case-hardened

Drawing

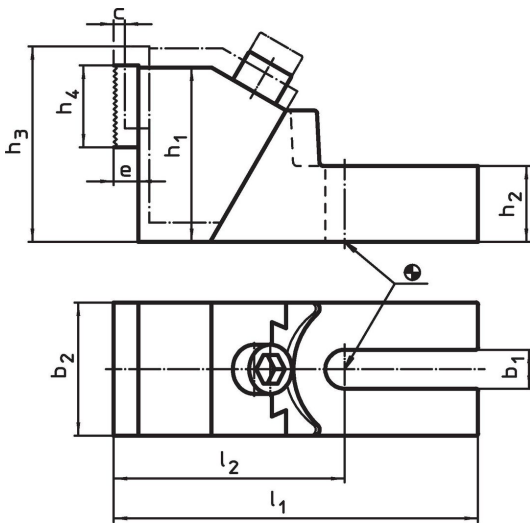

Order information

Dimensions										T-slot size	Clamping force		Art. No.	
b ₁	c	h ₁	h ₂	h ₃	h ₄	b ₂	l ₁	l ₂	e	a	F ₁	F ₂		
[mm]										[mm]	[kN]		[kg]	
19	8	85	37	99	40	65	177.5	112.5	12	12	8	1.2	4	23240.0012
										14	15	2.2		
										16	20	3.0		
										18	28	4.2		

Application example

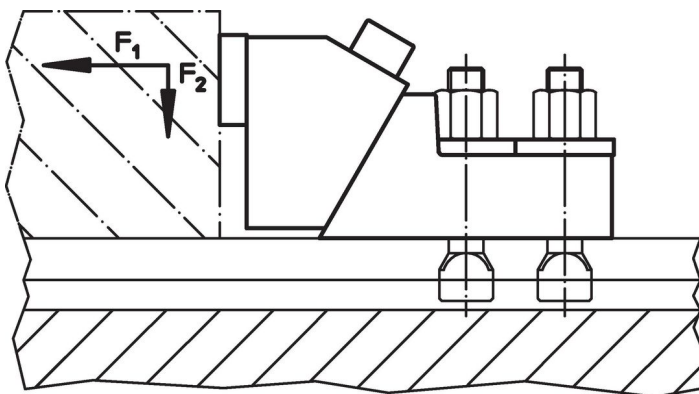

Compliance

RoHS compliant

Compliant according to Directive 2011/65/EU and Directive 2015/863.

Does not contain SVHC substances

No SVHC substances with more than 0.1% w/w contained - SVHC list [REACH] as of 27.06.2024.

Does not contain Proposition 65 substances

No Proposition 65 substances included.

<https://www.P65Warnings.ca.gov/>

Free from Conflict Minerals

This product does not contain any substances designated as "conflict minerals" such as tantalum, tin, gold or tungsten from the Democratic Republic of Congo or adjacent countries.