

Eccentric Quick Clamps · with screw

23390.0330



Product Description

For quick and easy clamping and releasing of workpieces.
When using the "adjustable" design (picture 2) the lever position can be moved.

Material

Support washer

- Thermoplastic POM, glass-fiber reinforced

Lever

- Zinc die-cast, plastic coated, black, similar to RAL 9005

Inner parts

- Stainless steel 1.4305

Screw

- Stainless steel 1.4305

Adjusting nut

- Stainless steel 1.4305

Drawing

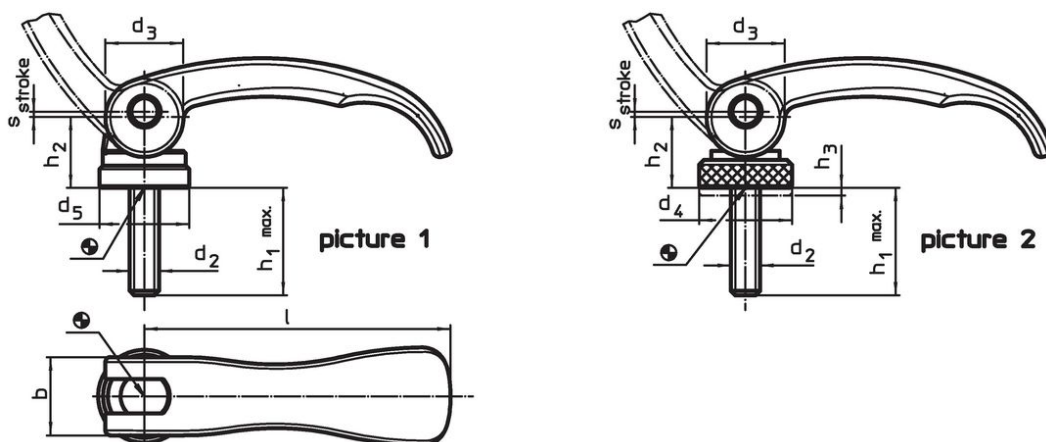

Order information

l	d ₂	h ₁ max. in clamping position	Dimensions					Regulating- range h ₃ min.	b	Stroke s at 90° lever position [mm]	max. [°C]	[g]	Art. No.
			d ₃	d ₄	h ₂ max.	[mm]							
with screw, adjustable – picture 2, Stainless steel													
63	M5	16	16	19	16.4	1.5	16	0.75	80	68	23390.0330		

Application example



Compliance

RoHS compliant

Compliant according to Directive 2011/65/EU and Directive 2015/863.

Does not contain SVHC substances

No SVHC substances with more than 0.1% w/w contained - SVHC list [REACH] as of 27.06.2024.

Does not contain Proposition 65 substances

No Proposition 65 substances included.

<https://www.P65Warnings.ca.gov/>

Free from Conflict Minerals

This product does not contain any substances designated as "conflict minerals" such as tantalum, tin, gold or tungsten from the Democratic Republic of Congo or adjacent countries.