

## Fulcrum Pins 23400.0105



### Product Description

#### Material

**Fulcrum Pin**  
• Stainless steel 1.4021, heat-treated

**Safety ring**  
• Stainless steel 1.4310

#### More information

#### References

Suitable for eccentric levers EH 23390. and similar applications.

### Drawing

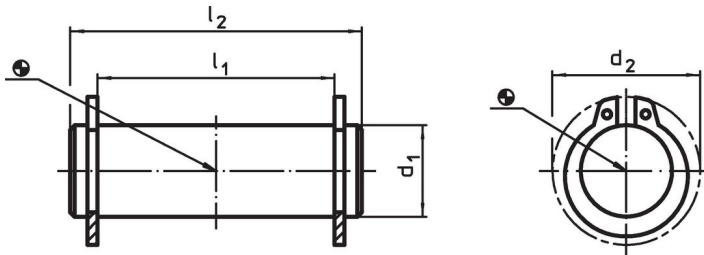

### Order information

Dimensions					[g]	Art. No.
$d_1$	$l_1$	$d_2$	$l_2$	[mm]		
f8	-0.5					
10	29	17	35		21	23400.0105

### Application example

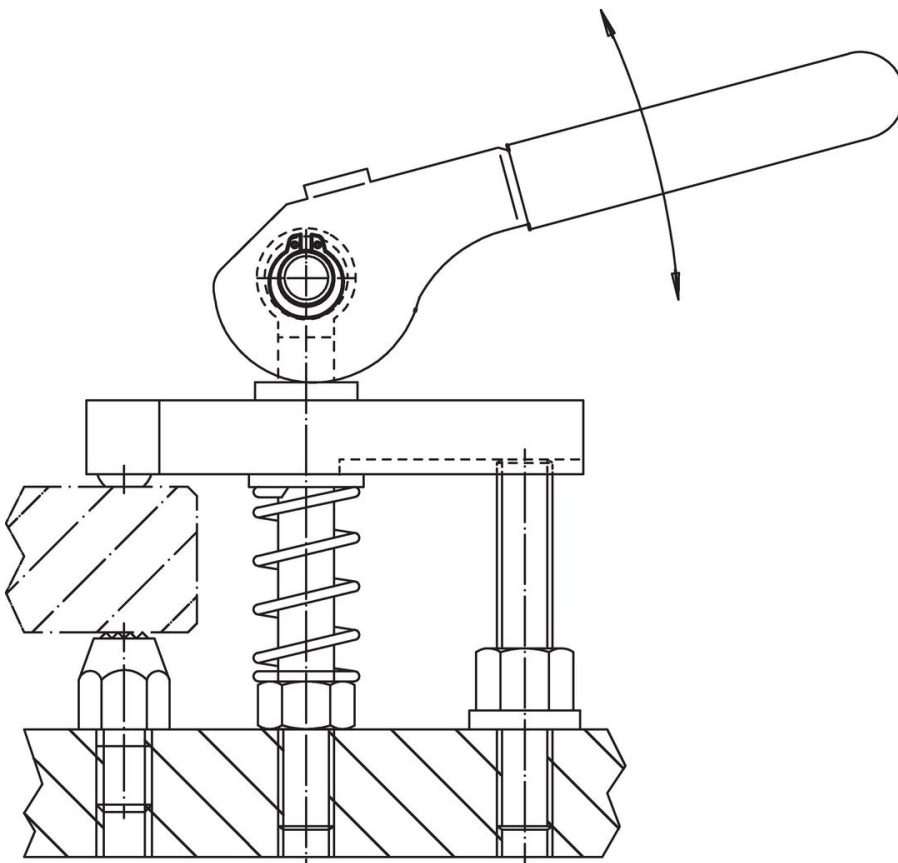

## Compliance

### RoHS compliant

Compliant according to Directive 2011/65/EU and Directive 2015/863.

### Does not contain SVHC substances

No SVHC substances with more than 0.1% w/w contained - SVHC list [REACH] as of 27.06.2024.

### Does not contain Proposition 65 substances

No Proposition 65 substances included.

<https://www.P65Warnings.ca.gov/>

### Free from Conflict Minerals

This product does not contain any substances designated as "conflict minerals" such as tantalum, tin, gold or tungsten from the Democratic Republic of Congo or adjacent countries.