

Base Elements · swivelling

23700.0416



Product Description

Material

Body

- Steel, blackened

Wearing parts

- Heat-treated steel

Pull-rod

- Special steel

Drawing

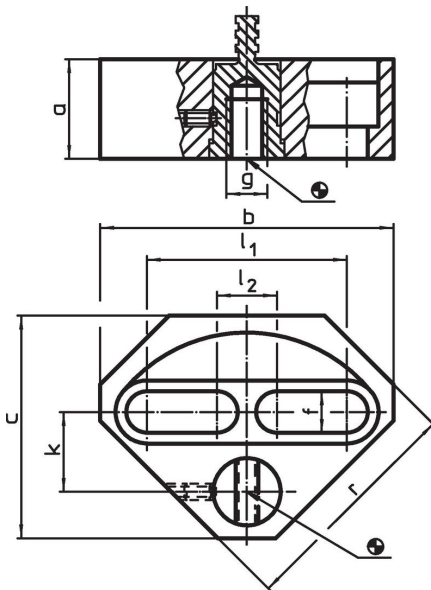

Order information

Dimensions										[g]	Art. No.
a	b	c	f	g	k	l ₁	l ₂	r	[mm]		
39.7	110	86	17	M16	30	71	31	90		1507	23700.0416

Application example



Compliance

RoHS compliant

Compliant according to Directive 2011/65/EU and Directive 2015/863.

Does not contain SVHC substances

No SVHC substances with more than 0.1% w/w contained - SVHC list [REACH] as of 27.06.2024.

Does not contain Proposition 65 substances

No Proposition 65 substances included.

<https://www.P65Warnings.ca.gov/>

Free from Conflict Minerals

This product does not contain any substances designated as "conflict minerals" such as tantalum, tin, gold or tungsten from the Democratic Republic of Congo or adjacent countries.