

## Adjustable Clamping Levers · inner parts from stainless steel, with screw

24390.0371



### Product Description

Adjustable clamping levers with rust-proof inner parts. Suitable for multiple applications, e.g. medical environments, chemical industry, and so on.

### Material

#### Lever

- Zinc die-cast, plastic coated, orange similar to RAL 2004, matt structure

#### Inner parts

- Stainless steel 1.4305

#### Screw

- Stainless steel 1.4305

### Operation

**By lifting the lever** the serrations are disengaged. The lever can be positioned by the serrations. On releasing the lever, the serrations are automatically re-engaged.

### More information

### Notes

The screw part can be exchanged.

### Drawing

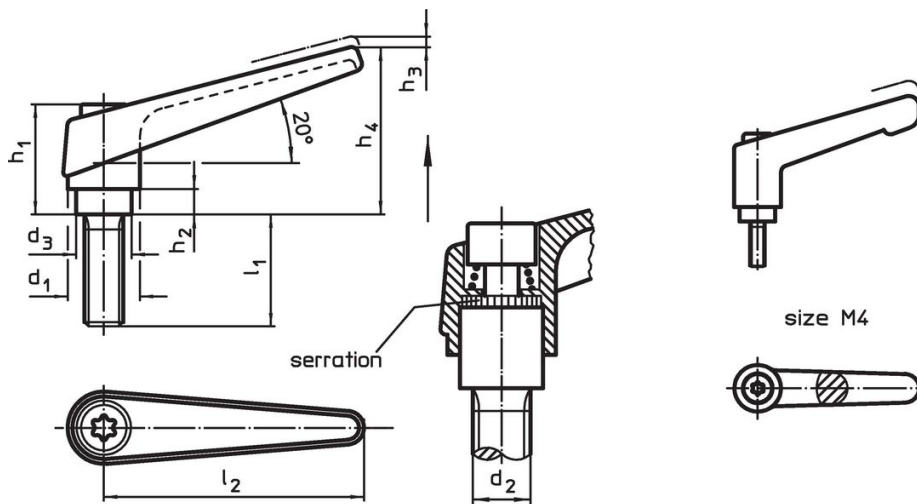

### Order information

Dimensions										[g]	Art. No.	
$d_1$	$d_2$	$l_1$	$d_3$	$h_1$	$h_2$	$h_3$	$h_4$	$l_2$	[mm]			
orange												
18	M8	40	13.5	31	6.5	3	45	62		81	24390.0371	

## Application example



## Compliance

### RoHS compliant

Contains lead - compliant according to exceptions 6a / 6b / 6c.

### Contains SVHC substances >0,1% w/w

Contains lead - SVHC list [REACH] as of 27.06.2024.

### Contains Proposition 65 substances



Lead can cause cancer and reproductive harm from exposure  
<https://www.P65Warnings.ca.gov/>

### Free from Conflict Minerals

This product does not contain any substances designated as "conflict minerals" such as tantalum, tin, gold or tungsten from the Democratic Republic of Congo or adjacent countries.