

Adjustable Clamping Levers · with clamping screw

24410.0191



Product Description

Adjustable clamping levers find versatile applications when the area of use is confined or a specific lever position is required.

Material

Lever

- Zinc die-cast, plastic coated, orange similar to RAL 2004, matt structure

Inner parts

- Steel, blackened, quality 5.8

Screw

- Steel, blackened, quality 5.8

Operation

By lifting the lever the serrations are disengaged. The lever can be positioned by the serrations. On releasing the lever, the serrations are automatically re-engaged.

More information

Notes

The screw part can be exchanged.

References

The version with ball-headed (picture 3) can be combined with the thrust piece, plastic (EH 22570.).

Further products

- Thrust Pads, plastic

Drawing

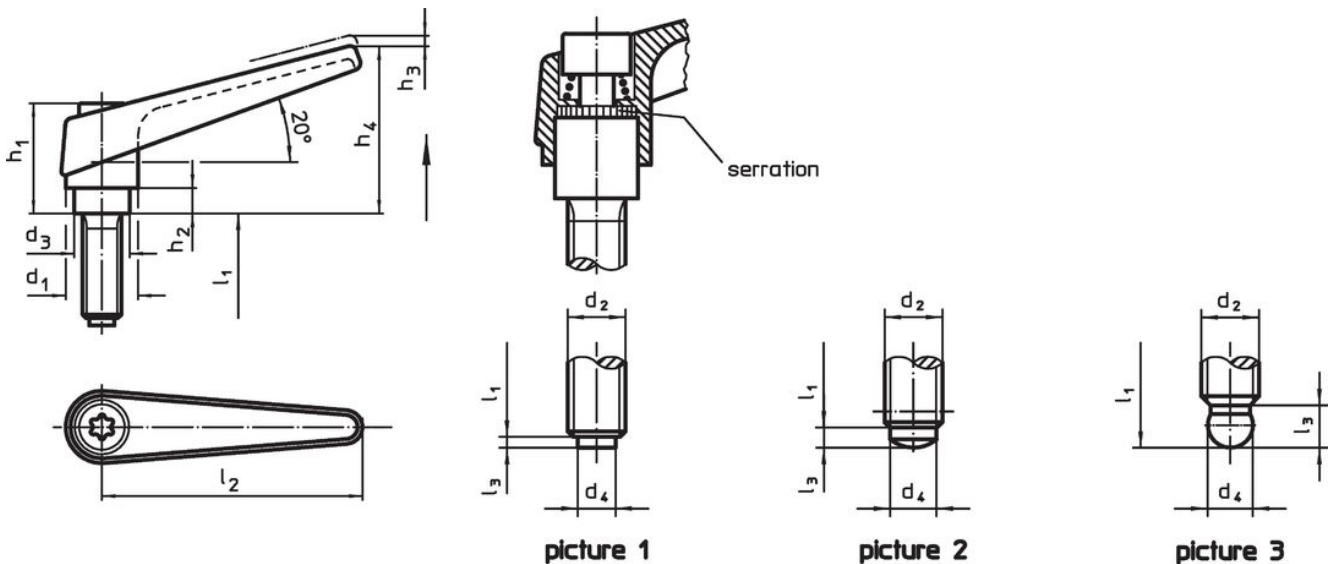

Order information

Dimensions											[g]	Art. No.
d ₁	d ₂	l ₁	d ₃	d ₄	h ₁	h ₂	h ₃	h ₄	l ₂	l ₃		
with plastic thrust pin – picture 1, orange												
14	M6	50	10	4	24.5	4	3	35	45	1	45	24410.0191

Compliance

RoHS compliant

Contains lead - compliant according to exceptions 6a / 6b / 6c.

Contains SVHC substances >0,1% w/w

Contains lead - SVHC list [REACH] as of 27.06.2024.

Contains Proposition 65 substances



Lead can cause cancer and reproductive harm from exposure
<https://www.P65Warnings.ca.gov/>

Free from Conflict Minerals

This product does not contain any substances designated as "conflict minerals" such as tantalum, tin, gold or tungsten from the Democratic Republic of Congo or adjacent countries.