

Folding Handles · rotating

24532.0123



Product Description

Material

Axle part

- Stainless steel 1.4305

Handle

- Thermoplastic, black, dull

Operation

In the operating position the handle is locked. To move the handle to the rest position, it must be pulled out axially and flipped round.

Drawing

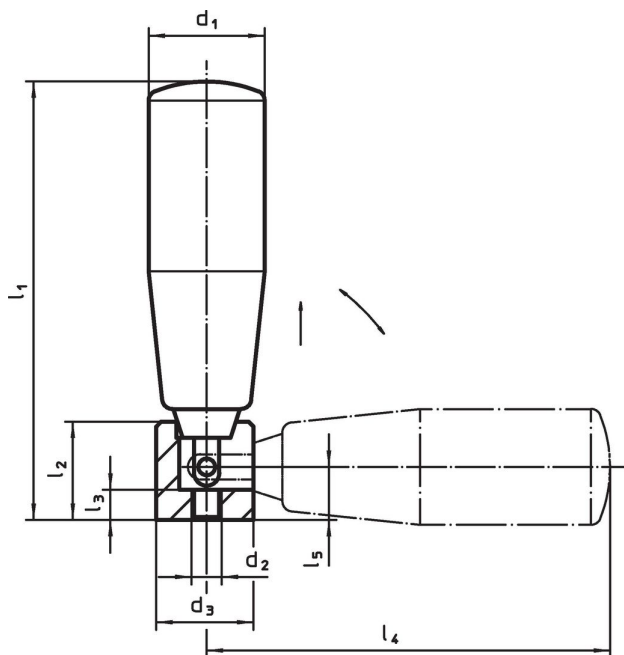

Order information

Dimensions								max. [°C]	[g]	Art. No.
d ₁	d ₂	d ₃	l ₁ ~	l ₂	l ₃	l ₄ ~	l ₅			
Stainless steel										
23	M6	20	87	19.5	6	80	10.5	110	111	24532.0123

Compliance

RoHS compliant

Compliant according to Directive 2011/65/EU and Directive 2015/863.

Does not contain SVHC substances

No SVHC substances with more than 0.1% w/w contained - SVHC list [REACH] as of 27.06.2024.

Does not contain Proposition 65 substances

No Proposition 65 substances included.

<https://www.P65Warnings.ca.gov/>

Free from Conflict Minerals

This product does not contain any substances designated as "conflict minerals" such as tantalum, tin, gold or tungsten from the Democratic Republic of Congo or adjacent countries.