

Handwheels • similar to DIN 950, stainless steel

24591.0415



Product Description

Hub machined; rim turned and mirror-finished on all sides, non-machined surfaces cleanly blasted.

Material

Handwheel

- Stainless steel A4

Machine handle

- Stainless steel A4

Assembly

Shaft-end washers EH 22270. for axial fastening.

More information

Further products

- Shaft-End Washers

Drawing

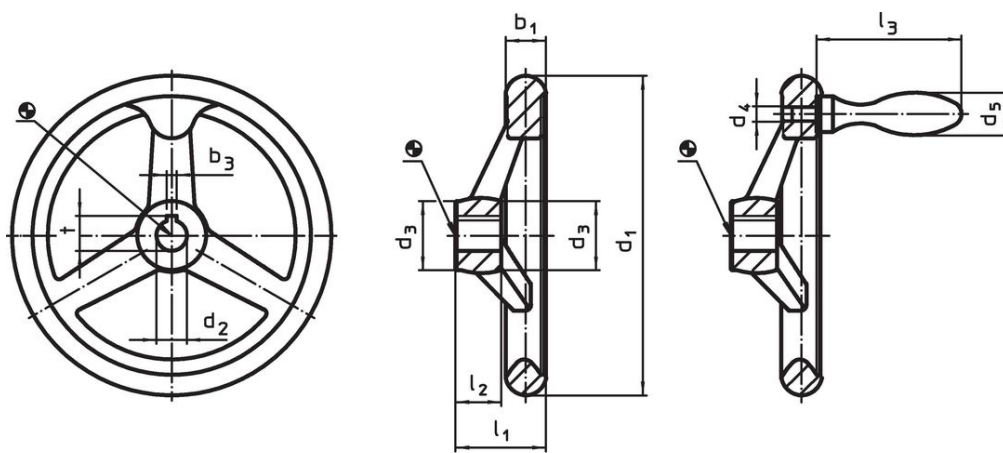

picture 1

picture 2

The orientation of the hub keyway may be different than shown in the drawing.

Order information

Dimensions								Number of spokes	Corresponding machine handle DIN 39 [mm]	 [g]	Art. No.
d ₁	d ₂ H9	d ₃	d ₄	d ₅	l ₁	l ₂	l ₃ ~				
without hub keyway, with machine handle EH 24450., assembled, form B-F/G (formerly: F 4) – picture 2											
140	14	29	M8	20	38.5	19	64	3	20	939	24591.0415

Compliance

RoHS compliant

Compliant according to Directive 2011/65/EU and Directive 2015/863.

Does not contain SVHC substances

No SVHC substances with more than 0.1% w/w contained - SVHC list [REACH] as of 27.06.2024.

Does not contain Proposition 65 substances

No Proposition 65 substances included.

<https://www.P65Warnings.ca.gov/>

Free from Conflict Minerals

This product does not contain any substances designated as "conflict minerals" such as tantalum, tin, gold or tungsten from the Democratic Republic of Congo or adjacent countries.