

## Tapered Shaft Hubs · with lock nut

25050.0114



### Product Description

It is a self-centering and non-floating tapered shaft hub in corrosion-protected design with a hexagon nut and a lock nut.

The rotational accuracy of the tapered shaft hubs is 0,03 mm.

By using tapered shaft hubs, all shaft-hub joints of machine elements such as sprocket wheels, gear wheels, belt pulleys, cams, levers etc. can be easily and efficiently established.

### Material

#### External part

- Steel, zinc-plated by galvanization

#### Inner part

- Steel, nickel-plated

#### Nut

- Steel, nickel-plated

### Assembly

The lock nut at the outer part facilitates locking of the shaft-hub joint if freely rotating shafts are involved. For mounting, a crescent wrench (thickness max.  $l_2-l_3$ ) is used.

### More information

### References

Comply with mounting instructions, mounting examples, and technical data.

### Drawing

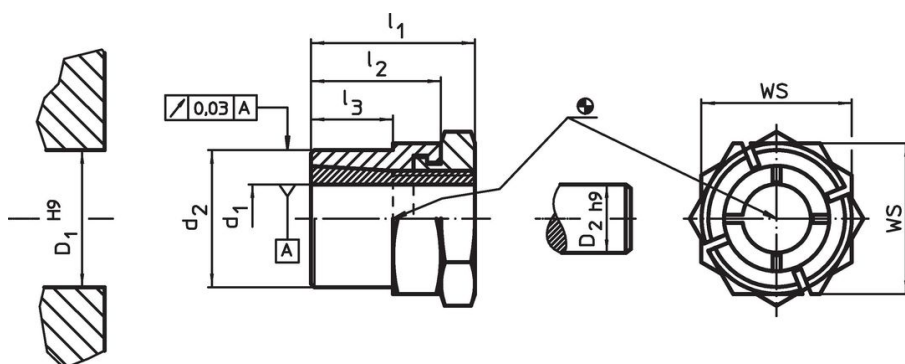

### Order information

Dimensions					WS [mm]	Tightening torque of the nut $T_A$ max. [Nm]	Transferable torque M max. [Nm]	Transferable axial load $F_a$ max. [kN]	Surface pressure of shaft $p_w$ max. [N/mm <sup>2</sup> ]	Surface pressure of hub $p_N$ max. [N/mm <sup>2</sup> ]	Hub bore $D_1$ H9 [mm]	Shaft diameter $D_2$ h9 [mm]	[g]	Art. No.
$d_1$	$d_2$	$l_1$	$l_2$	$l_3$										
14	24	28	22	15	27	65	93	13.3	178	107	24	14	77	25050.0114

### Accessories

	WS [mm]	[g]	Art. No.
special fork wrench			
	27	195	25050.0827

## Application example



## Compliance

### RoHS compliant

Compliant according to Directive 2011/65/EU and Directive 2015/863.

### Does not contain SVHC substances

No SVHC substances with more than 0.1% w/w contained - SVHC list [REACH] as of 27.06.2024.

### Does not contain Proposition 65 substances

No Proposition 65 substances included.  
<https://www.P65Warnings.ca.gov/>

### Free from Conflict Minerals

This product does not contain any substances designated as "conflict minerals" such as tantalum, tin, gold or tungsten from the Democratic Republic of Congo or adjacent countries.