

Ball Lock Pins • single acting - comply with NAS / MS17984

4210.D17



Product Description

Ball Lock Pins according to MS17984 / NAS1333 - 1343 are used for quick fastening, locking, adjusting, changing and securing. Quickly and easily unlockable for frequently repeated connections.

Ball Lock Pins (Quick Release Pins) are produced according to Aviation Norm MS / NAS and tested to NAS 1332.

Surface treatment:

- All stainless steel parts are passivated according AMS2700
- All aluminium parts alloy anodized according MIL-A-8625

Heat treatment:

- Body: Rc. 40 min. (AMS2759, Condition H900)
- Spindle: Rc. 40 min. (AMS2759, Condition H900)
- Ball: Rc. 58-62 min. (AMS2759)

Material

Body

- Stainless steel, precipitation-hardened, passivated - CRES 17-4PH (specification AMS5643)

Spindle

- Stainless steel, precipitation-hardened, passivated - CRES 17-4PH (specification AMS5643)

Spring

- Stainless steel, passivated - CRES 302 (specification ASTM-A-313)

Handle

- From 3/8" - Aluminium, black anodised - Alum.Alloy 6061-T6 (specification AMS-QQ-A200/8)

Attaching ring

- Stainless steel, passivated - CRES 302 (specification ASTM A-313/A313M)

Press button

- Stainless steel, passivated - CRES 303 (specification ASTM A484/484M)

Ball

- Stainless steel, precipitation-hardened, passivated - CRES 440C (specification AMS5630)

Operation

Ball lock pins single acting are self-locking and require a push of the button to release the balls.

More information

Notes

All further dimensions are available on request.



Other diameter / length combinations not listed which comply with the standard can be produced at short notice on customer request. Special types on request.

- This product is manufactured in INCH dimensions.

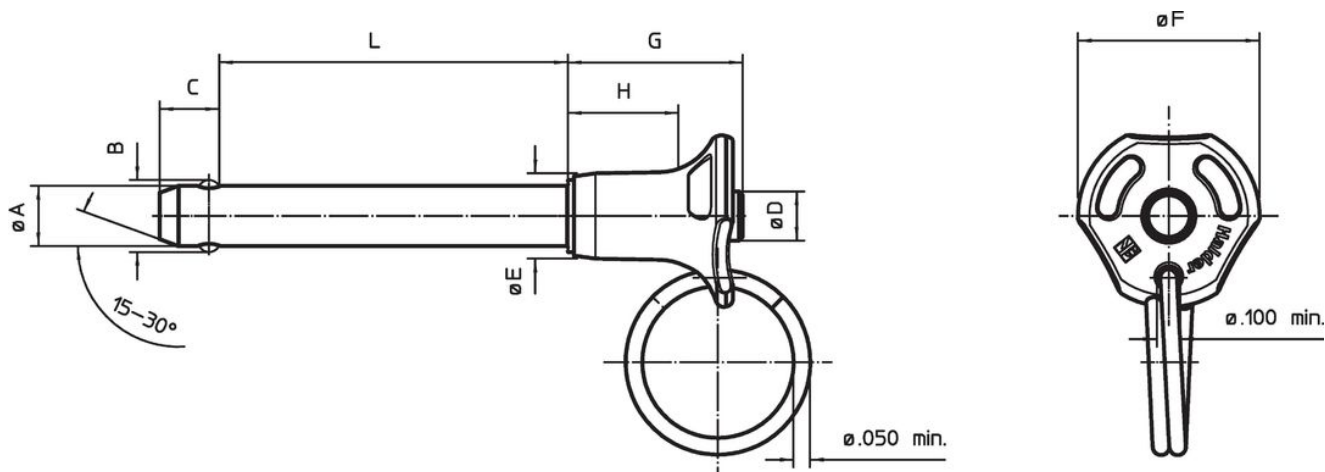
Drawing



Order information

Nominal diameter A	A		Clamping length L +0.02 0	Dimensions						Location hole max.	Shearing resistance, two-shear min.	 min. max.		 [g]	Standard description	Art. No.	
	min.	max.		B ±0.005	C 0 -0.04	D max.	E max.	F max.	G max.			H min.	[in]				[lb]
[in]	[in]	[in]	[in]	[in]						[in]	[lb]	[°F]		[g]			
3/8	0.372	0.3735	1.7	0.44	0.36	0.39	0.57	1.135	1.04	0.62	0.379	20,700	-65	200	45.4	MS17984C617 / NAS1336A3C17D	4210.D17

Compliance

RoHS compliant

Compliant according to Directive 2011/65/EU and Directive 2015/863.

Does not contain SVHC substances

No SVHC substances with more than 0.1% w/w contained - SVHC list [REACH] as of 27.06.2024.

Does not contain Proposition 65 substances

No Proposition 65 substances included.

<https://www.P65Warnings.ca.gov/>

Free from Conflict Minerals

This product does not contain any substances designated as "conflict minerals" such as tantalum, tin, gold or tungsten from the Democratic Republic of Congo or adjacent countries.