

Lanyards • according to NSA5732

4219.100



Product Description

Lanyards are used as loss-protection, for example for ball lock pins. Retaining cables are characterised by their light and elastic construction. In addition to the standard variants, we also manufacture all other variants (length from 100 mm to 950 mm / in 50 mm steps) and designs (600 N tensile force) in compliance with the standard. Short delivery times are possible.

Material

Cord

- Polyamide fabric, white

key ring

- Stainless steel

Shrinking hose

- Plastic, black (according to NSA937502-03)

More information

Notes

Further information on request.
Special types on request.

Further products

- Retaining Cables
- Lanyards, according to DAN80

Drawing

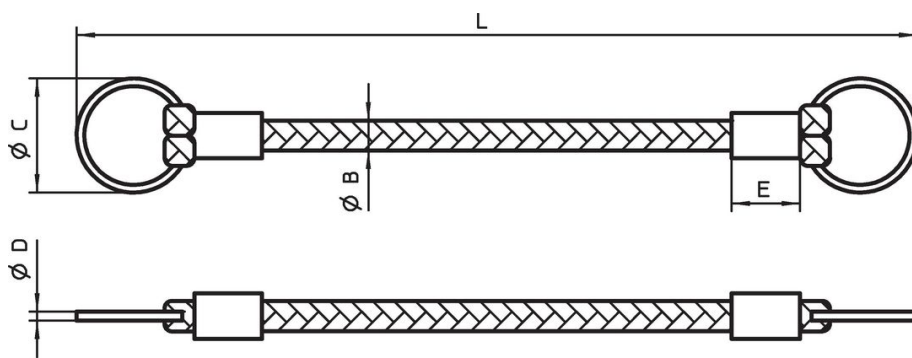

Order information

L	B	Dimensions			E	Tensile force		Art. No.
		C	D			min.	max.	
+5								
-3								
		[mm]				[N]	[g]	
100	3	14	1.2	10	150	2	4219.100	

Compliance

RoHS compliant

Compliant according to Directive 2011/65/EU and Directive 2015/863.

Does not contain SVHC substances

No SVHC substances with more than 0.1% w/w contained - SVHC list [REACH] as of 27.06.2024.

Does not contain Proposition 65 substances

No Proposition 65 substances included.

<https://www.P65Warnings.ca.gov/>

Free from Conflict Minerals

This product does not contain any substances designated as "conflict minerals" such as tantalum, tin, gold or tungsten from the Democratic Republic of Congo or adjacent countries.