

Down-Thrust Clamps · swivelling, low construction, size 44

EH 23310.

**Product Description**

Universal mechanical clamping element for fast and comfortable changing and clamping of workpieces by means of manually swivelling clamping claw.

The clamps have the following advantages:

- Rapid manual clamping by means of clamping screw or double eccentric lever.
- Easy and rapid changing of workpieces by swinging away the clamping claw to the left or right.
- Low design, thus little space taken-up for clamping.
- Easy adjustment even to large clamping heights due to the height adjusting cylinders.

As the force applied by the operator is not known for the versions with levers, the clamping force is given in the tables as a guide value. The average value was determined by tests.

Material

- Case-hardened steel, case-hardened, blackened and ground

Assembly

Down-thrust clamps can be attached in two ways:

1. in a T-slot, using a nut for T-slots DIN 508 (EH 23010.)
2. with the set screw directly in the mounting plate of, for example, a fixture
The cylinder must make contact over the whole surface.

More information**References**

The clamping height can be increased using height adjusting cylinders EH 23310. and with spacers EH 1107. and EH 1108.

Further products

- Height Adjusting Cylinders
- Spacers
- Wrenches

Drawing

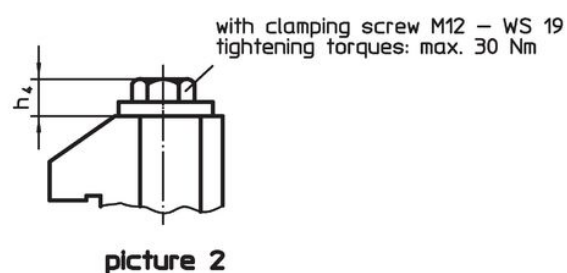
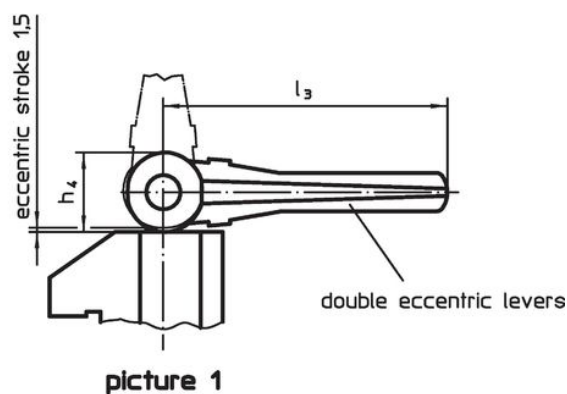
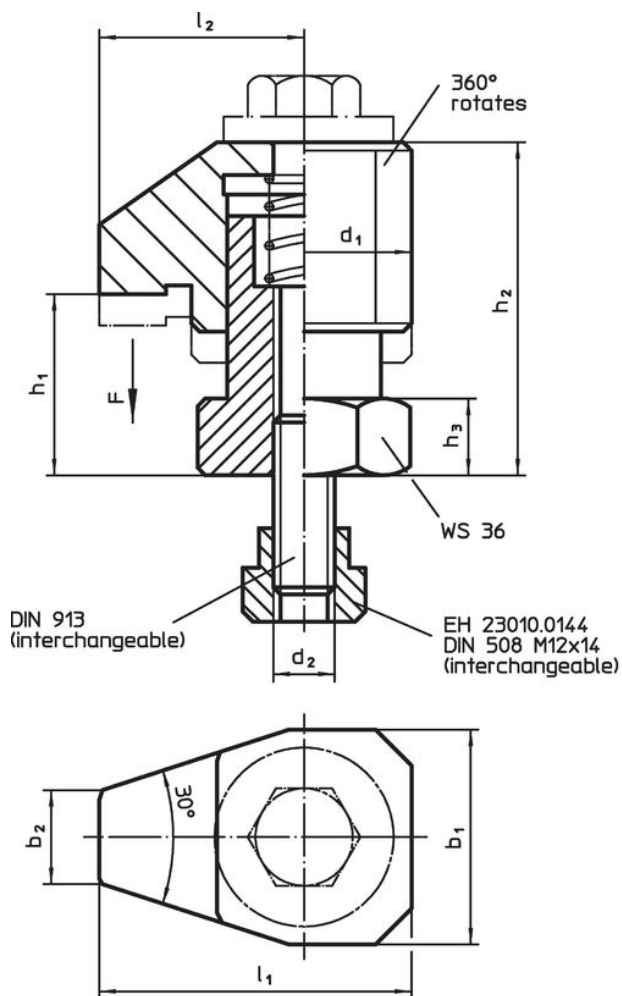

Order information

d ₁	b ₁	b ₂	d ₂	Dimensions							Stroke	Clamping force	Tightening torque max.	🔩	Art. No.			
				h ₁	h ₂	h ₃	h ₄	l ₁	l ₂	l ₃								
[mm]														[mm]	[kN]	[Nm]	[g]	
with double eccentric levers – picture 1																		
44	42	18	M12	25 – 30	54 – 59	15	28	61	40	100	5	4 ¹⁾	–	1022	23310.0034			
with clamping screw – picture 2																		
44	42	18	M12	25 – 30	54 – 59	15	13	61	40	–	5	10	30	708	23310.0035			

¹⁾ Average value established in trials.

Application example

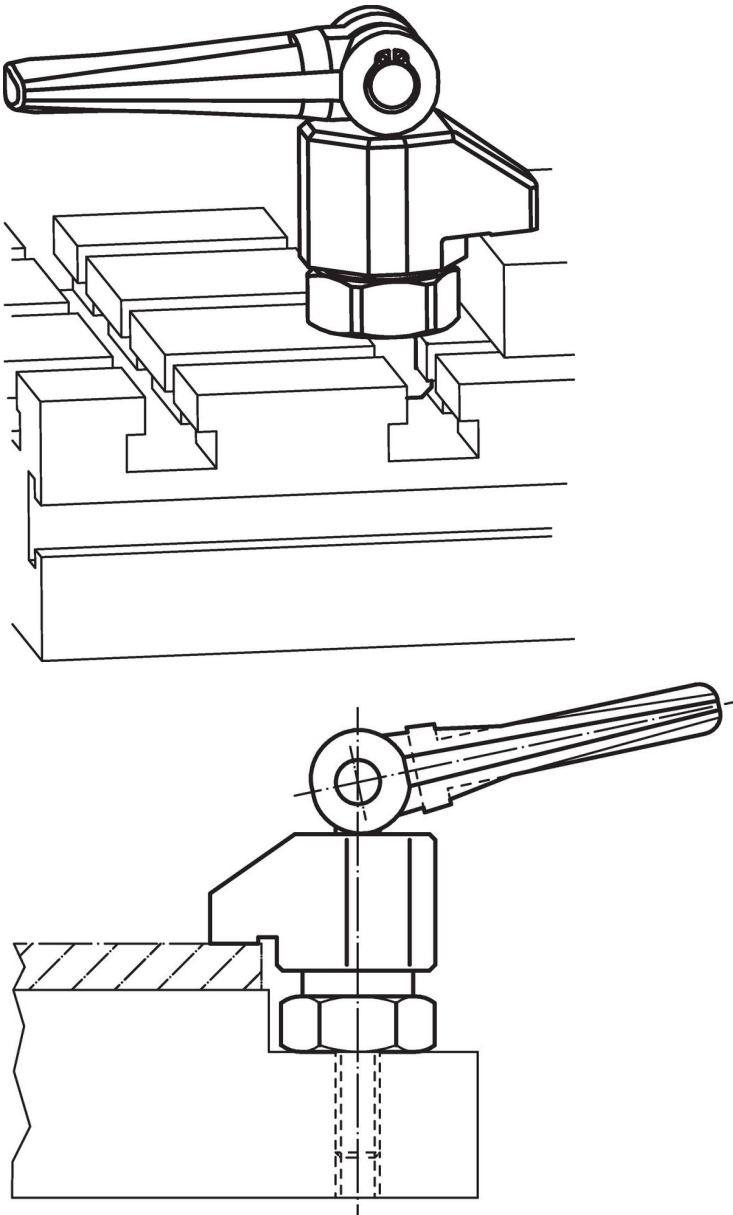

Compliance

RoHS compliant

Contains lead - compliant according to exceptions 6a / 6b / 6c.

Contains SVHC substances >0,1% w/w

Contains lead - SVHC list [REACH] as of 27.06.2024.

Contains Proposition 65 substances



Lead can cause cancer and reproductive harm from exposure
<https://www.P65Warnings.ca.gov/>

Free from Conflict Minerals

This product does not contain any substances designated as "conflict minerals" such as tantalum, tin, gold or tungsten from the Democratic Republic of Congo or adjacent countries.