

Palm Grips • with axial bearing
EH 24700.



Product Description

Advantages of axial bearing:

- Double clamping force with same grip size, by reducing the surface friction.
- Protection of workpiece by a fixed locating surface.
- Little setting due to higher pre-clamping force of bolt resp. thread.

Material

Handle

- Thermoplastic PA

Inner part

- Steel, nitrided, blackened

Screw

- Steel, blackened, quality 8.8

Drawing

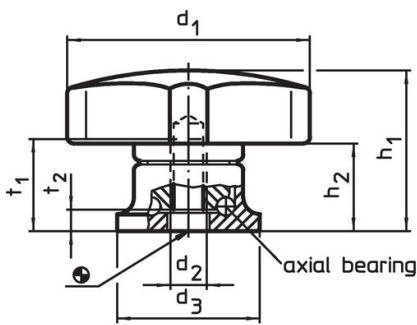

picture 1

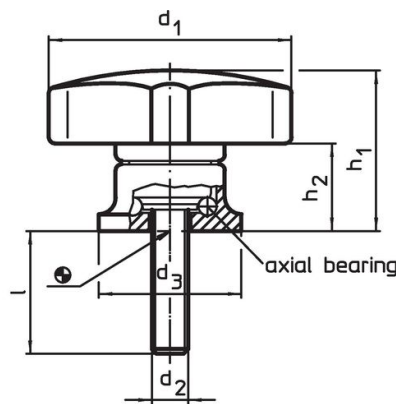

picture 2

Order information

Dimensions								max. [°C]	[g]	Art. No.
d ₁	d ₂	l +2	d ₃	h ₁ ~ [mm]	h ₂ ~	t ₁ min.	t ₂			
with female thread – picture 1										
40	M 6	–	24	27	15.0	12.5	5.0	80	45	24700.0040
50	M 8	–	25	34	22.5	14.0	4.2	80	68	24700.0050
63	M10	–	30	41	26.5	18.0	5.4	80	109	24700.0063
80	M12	–	35	54	34.0	26.5	6.6	80	213	24700.0080
with screw – picture 2										
40	M 6	15	24	27	15.0	–	–	80	51	24700.0042
40	M 6	25	24	27	15.0	–	–	80	52	24700.0044
50	M 8	20	25	34	22.5	–	–	80	81	24700.0053
50	M 8	35	25	34	22.5	–	–	80	86	24700.0056
63	M10	30	30	41	26.5	–	–	80	136	24700.0066
63	M10	40	30	41	26.5	–	–	80	141	24700.0068
80	M12	30	35	54	34.0	–	–	80	259	24700.0083
80	M12	50	35	54	34.0	–	–	80	273	24700.0087

Application example

Increase of clamping force with axial bearing
(while manual force is unchanged)

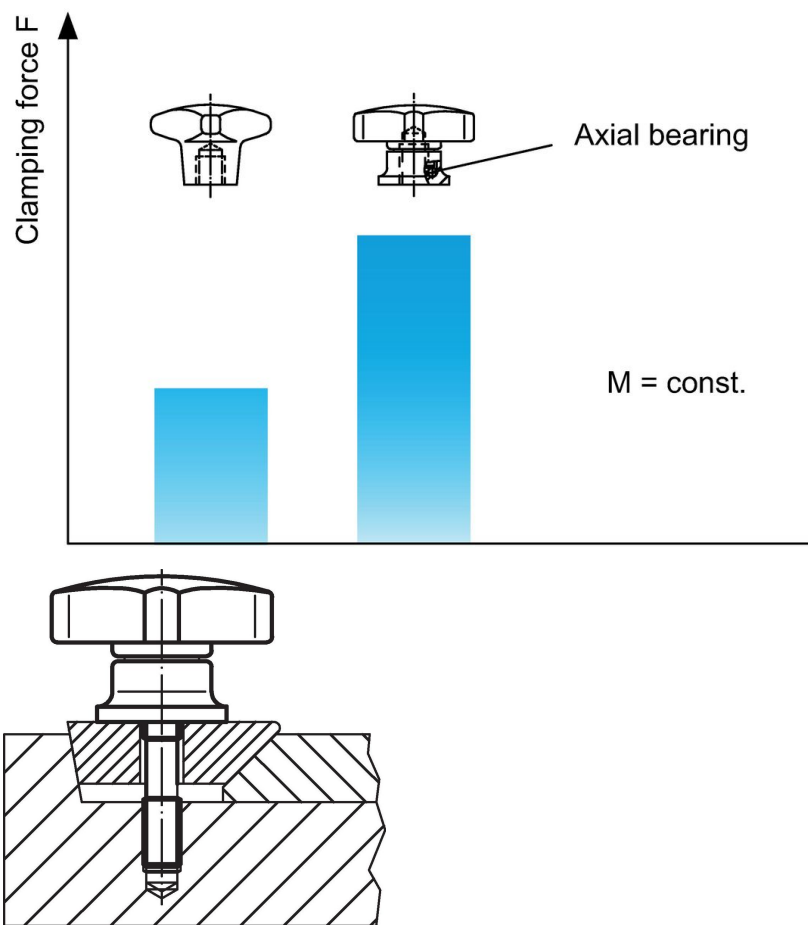

Compliance

RoHS compliant

Contains lead - compliant according to exceptions 6a / 6b / 6c.

Contains SVHC substances >0,1% w/w

Contains lead - SVHC list [REACH] as of 27.06.2024.

Contains Proposition 65 substances



Lead can cause cancer and reproductive harm from exposure
<https://www.P65Warnings.ca.gov/>

Free from Conflict Minerals

This product does not contain any substances designated as "conflict minerals" such as tantalum, tin, gold or tungsten from the Democratic Republic of Congo or adjacent countries.